

TPB Integrated Smart LED Tri-proof light

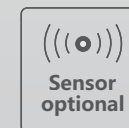
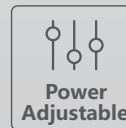

Description:

TPB is a modular designed, highly durable, robust water-proof and dustproof light. With a uniform light distribution designed for industrial applications. The flexible rust and corrosion free mounting clamps for wall / ceiling provides very easy installation. This modern and efficient tri-proof light is the ideal lighting solution for factories and production areas, parking lots, corridors, hallways, warehouses and storage rooms, stairways etc.

Features:

1. Modular design: Single installation, Cable connection & seamless connection optional.
2. Plug & play sensors and emergency modules: Easy & flexible installation, can be installed wherever needed.
3. Tool free installation: 10s to complete the installation.
4. Self-Diagnostic Emergency driver: Automatic monthly & annual testing.
5. CCT & power tunable :Less SKU.

Daylight Priority:

Dusk/Dawn sensor:

Dual-PD technology brings a fully automatic dusk/dawn sensor which can tell the difference between natural light and LED light, to ensure the light will be off when needed.

Precondition of Daylight priority:

1. Daylight threshold is on 30Lux/50Lux/80Lux/120Lux;
2. Standby period is +D ;
3. Standby dimming level is on 10%/20%/30%.

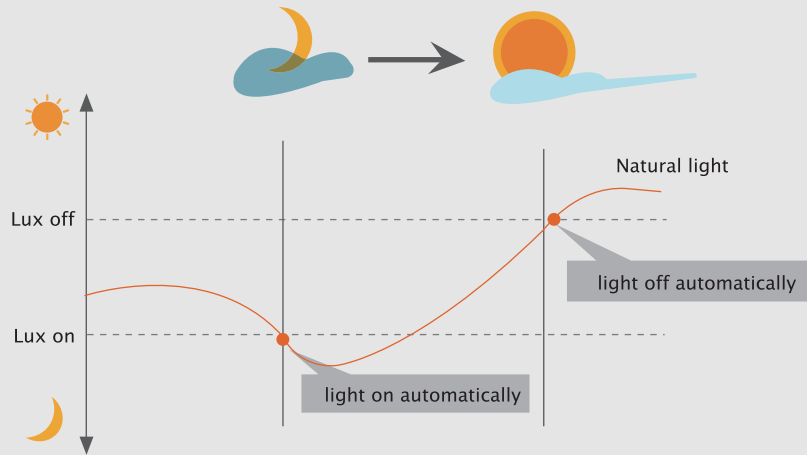

Application Daylight priority

- * Daylight threshold is on 30Lux/50Lux/80Lux/120Lux;
- * Standby period is +D; Standby dimming level is on 10%/20%/30%.

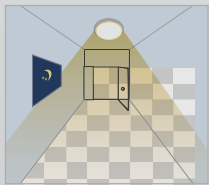

Light automatically on when ambient brightness is lower than preset lux level.

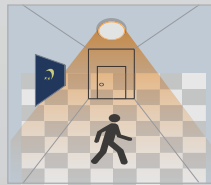

With insufficient ambient brightness, light dims to 100% when motion detected.

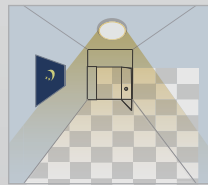

Light dims to standby level if no motion detected after holdtime.

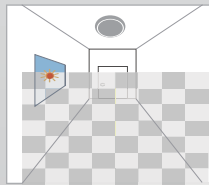

Light off when ambient lux level is higher than preset lux amount.

Application :

1. Automatically ON/OFF function:

- * Daylight threshold is on 2Lux/10Lux/30Lux/50Lux/80Lux/120Lux/200Lux/250Lux/300Lux/350Lux/400Lux;
- * Standby period is 0s; Light on when detect movement and off after people leave at night. Applications: Corridor, Staircase.

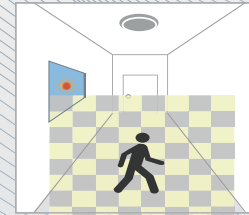

With sufficient daylight, even when motion detected, light remains OFF.

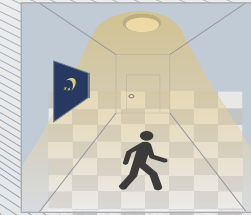

With insufficient daylight, when motion detected, light ON.



After the last detection and the present hold time elapsed, light OFF.

2. No daylight function

- * Daylight threshold is on 排isable Standby period is on 0s/10s/30s/1min/5min/10min/30min.
- * Light on when detect movement, After people leave, Light off after stand-by period.
- * Stand-by period is set to +D , The light will always remain ON.

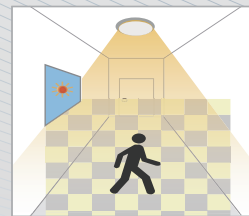

When motion is detected, the sensor will switch on the light to 100% brightness.

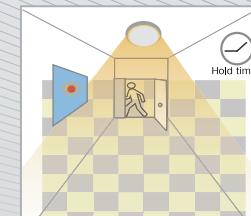

After people leave the detection area, light remains 100% brightness within hold time.

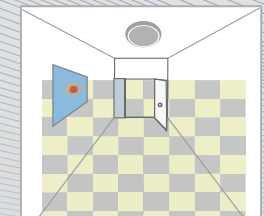

After the last detection and the present hold time elapsed, light OFF.

3. Function Demo – Dimmable control/Corridor function

- * Daylight threshold is on 2Lux/10Lux/30Lux/50Lux/80Lux/120Lux/200Lux/250Lux/300Lux/350Lux/400Lux;
- * Standby period is on 0s/10s/30s/1min/5min/10min/30min.
- * Light on when detect movement and off after people leave at night. Applications: Corridor, Staircase.

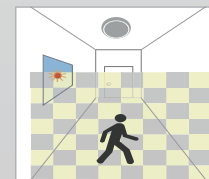

With sufficient daylight, even when motion detected, light remains OFF.



With insufficient daylight, when motion detected, light ON.

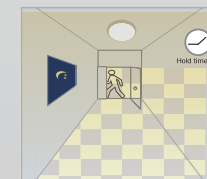



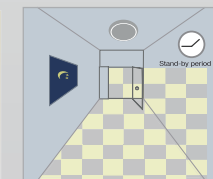





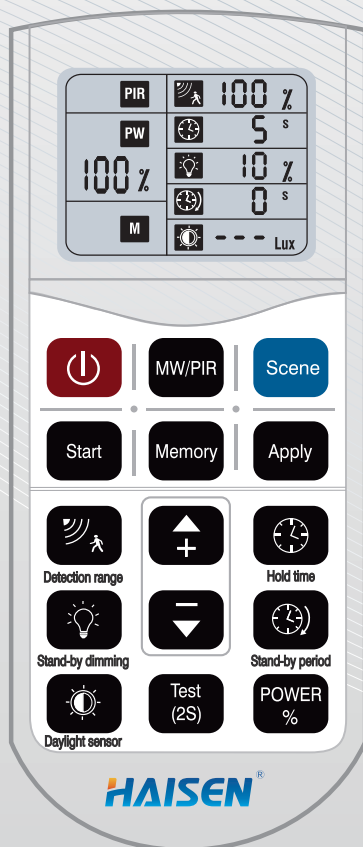







After last detection, the light will be dimmed down to the stand-by dimming level (10%, 20%, 30% or 50%) after holdtime.



After the stand-by period, light OFF.

HD05R Remote Control Keys Function Introduction:



Remote Keys	Keys Function	Keys Introduction
	ON/OFF	Switch ON/OFF the light, Switch OFF the sensor function.
	MW/PIR	Switch between MW and PIR mode. Letters flash in the corresponding window when press the key.
	Reset	Switch to Sensor mode and recover all settings to be factory defaulted setting(Detection area-100%, Hold time-5s, Daylight- Disable, Standby Period-0s, Stand-by dimming level-10%.
	Start	Press the key to start the setting of parameters with memory and apply function under the sensor mode.
	Memory	<ol style="list-style-type: none"> 1. Press "Start", there will be a letter "S" flashes in the lower left corner of the display, then start to set up all parameters; 2. After setting all parameters, press "Memory" to store the settings and keep it until the next reset; 3. Press "Apply" to the set sensor with stored settings within the remote IR range ; 4. Note: All data shown in the display are the settings after pressing "Memory".
	Apply	
	Detection area	
	Hold time	Under sensor mode, press the key, the corresponding icon on the display flashes, press "+"/"-" to select the hold time.
	Daylight Threshold	Under sensor mode, press the key, the corresponding icon on the display flashes, press "+"/"-" to select the daylight threshold.
	Stand-by period	Under sensor mode, press the key, the corresponding icon on the display flashes, press "+"/"-" to select the low brightness time.
	Stand-by dimming level	Under sensor mode, press the key, the corresponding icon on the display flashes, press "+"/"-" to select the low brightness during stand-by period.
	UP	After pressing different parameter keys, press either of the key to adjust(UP/DOWN) the required parameters.
	DOWN	
	POWER	Under sensor mode, press "POWER", the letter of "PW" flashes in the middle left of the display, press "+"/"-" to increase/decrease the output power.
	Test mode	Press the key to enter the test mode under sensor mode. It won't be memorized after power OFF. The parameters under test mode is: detection area-100%, hold time-2s, daylight-disable, stand-by period-0s, stand-by dimming level-10%.
Notes	Press"Scene" to reset the remote before using. During the setting of each parameter, the icon will flash for 5s, after that, the setting will be kept automatically.	

Application:

Warehouse, parking lot, foodstuffs factory, dust plant and refrigeratory and other sites.



Installation requirement:

1. Power off before installation.
2. Thread the input cable through the waterproof joint, and then connect the input wire end with the terminal to ensure reliable contact.
3. Fix the caps at both ends.
4. Choose ceiling installation, fix ceiling bracket on the installation surface via self-tapping screws and flat gasket, then snap the lamp body into bracket.
5. If you choose suspension installation, please first fix the steel wire on the installation surface, and fix the wirelock on bracket with nut, then snap the lamp body into bracket, finally adjust the length of steel wire.

Technical parameters:

Model	CCT	Lumen (lm) (±10%)	Beam angle	LEDs type	Voltage, frequency	Power(w) (±10%)	Max. current (A)	CRI	PF
TPB-T018-AH-60K-301/S301/E301/D301	5500-6500K	2350	120°	SMD2835	AC120-277V 50/60Hz	18	0.12	> 80	≥0.9
TPB-T018-AH-50K-301/S301/E301/D301	4700-5300K	2350							
TPB-T018-AH-40K-301/S301/E301/D301	3800-4200K	2340							
TPB-T018-AH-30K-301/S301/E301/D301	2700-3200K	2310							
TPB-T018-AH-TCK-301/S301/E301/D301	30K-40K-60K	2350							
TPB-T036-AH-60K-301/S301/D301	5500-6500K	4680	120°	SMD2835	AC120-277V 50/60Hz	36	0.25	> 80	≥0.9
TPB-T036-AH-50K-301/S301/D301	4700-5300K	4680							
TPB-T036-AH-40K-301/S301/D301	3800-4200K	4600							
TPB-T036-AH-30K-301/S301/D301	2700-3200K	4320							
TPB-T036-AH-TCK-301/S301/D301	30K-40K-60K	4600							
TPB-T050-AH-60K-301/S301/D301	5500-6500K	6500	120°	SMD2835	AC120-277V 50/60Hz	50	0.3	> 80	≥0.9
TPB-T050-AH-50K-301/S301/D301	4700-5300K	6500							
TPB-T050-AH-40K-301/S301/D301	3800-4200K	6400							
TPB-T050-AH-30K-301/S301/D301	2700-3200K	6000							
TPB-T050-AH-TCK-301/S301/D301	30K-40K-60K	6400							
TPB-T070-AW-60K-301/S301/D301	5500-6500K	9100	120°	SMD2835	AC120-277V 50/60Hz	70	0.5	> 80	≥0.9
TPB-T070-AW-50K-301/S301/D301	4700-5300K	9100							
TPB-T070-AW-40K-301/S301/D301	3800-4200K	9050							
TPB-T070-AW-30K-301/S301/D301	2700-3200K	8960							
TPB-T070-AW-TCK-301/S301/D301	30K-40K-60K	9100							

001/S001/E001/D001=Milky lamp shade series/Sensor series/Emergency series/DALI dimming series

301/S301/E301/D301=High output series/Sensor series/Emergency series/DALI dimming series

Dimensions(Unit:mm/inch):

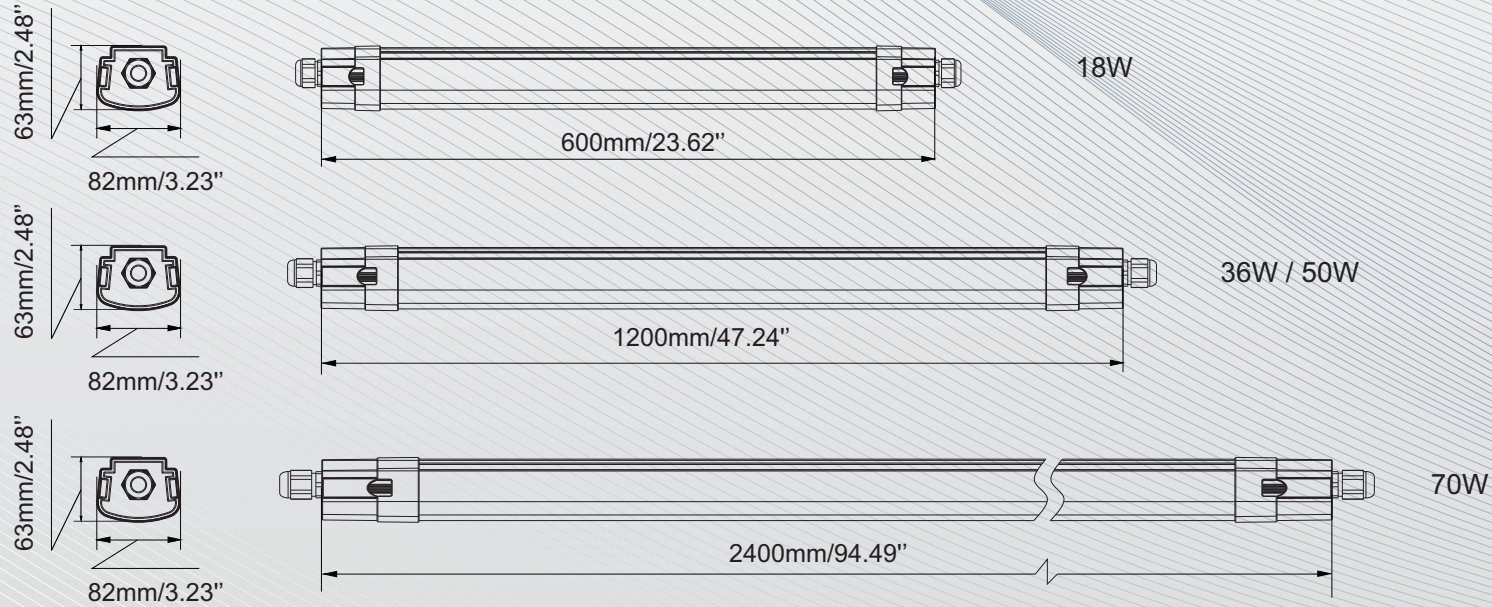

Product packaging information:

Size	Inner packing size	Carton size	Net weight	Gross weight	Quantity
0.6M	18W: 645*95*70mm	18W: 660*300*230mm	0.80Kg	1.00Kg	9pcs/Carton
1.2M	36W/50W: 1245*95*70mm	36W/50W: 1260*300*230mm	1.20Kg	1.70Kg	9pcs/Carton
2.4M	70W : 2445*95*70mm	70W: 2460*300*230mm	2.35Kg	3.40kg	9pcs/Carton

Accessories series:

CCT & Power Adjustable:

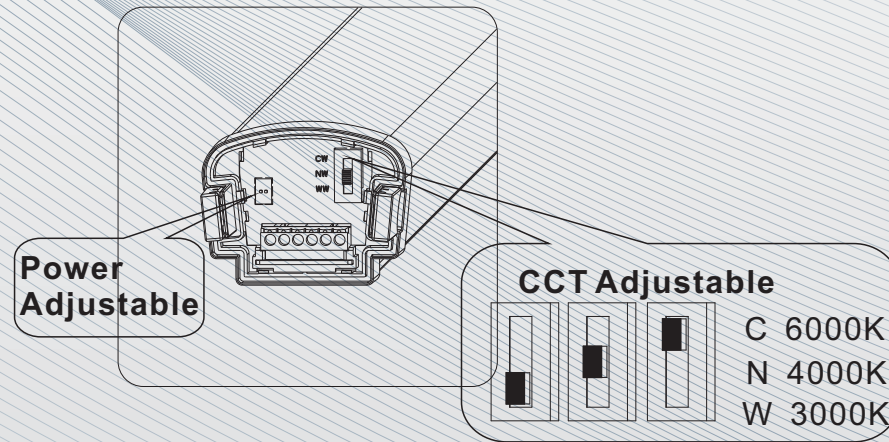
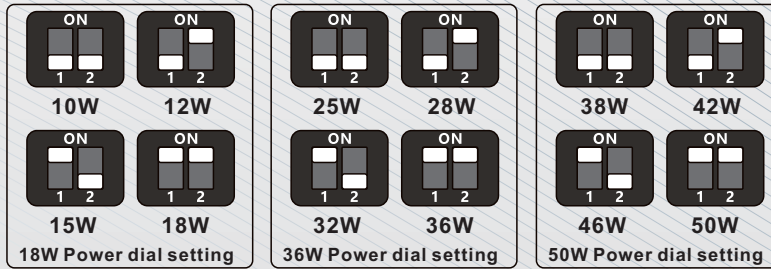

Emergency module



Single installation(Without Sensor)



Single installation(With Sensor)

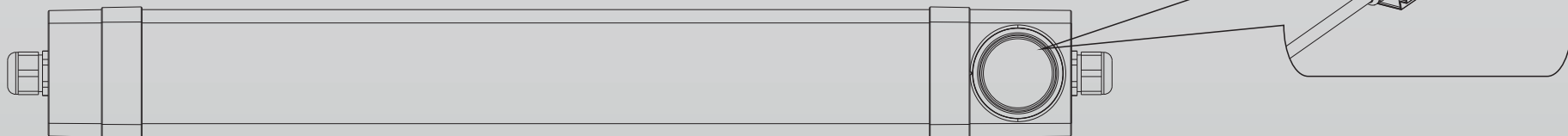

Cable connection:(without sensor)

MAX 800W



Cable connection:(with sensor)

MAX 800W



**Seamless connection:
(Without sensor)**

MAX 800W

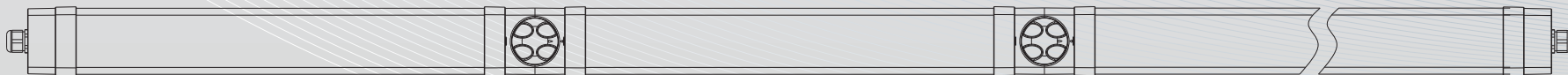

**Seamless connection:
(With sensor)**

MAX 800W

