



Signcomplex
light and smart



LED LINEAR LIGHT

-T85

ROUND VERSION





It can be used for home lighting, commercial lighting, engineering lighting and can be used in hotels, office buildings, shopping malls, entertainment places, etc

LED LINEAR LIGHT-T85 ROUND VERSION

Aluminum oxide shell is not easy to be scratched, strong metal texture

Thickened plastic side cover, not easy to deform, strong impact resistance

large luminous surface, 160° beam angle, wider irradiation area

SMD2835 LED

High luminous efficiency, UP to 120LM/W;

round PC cover

- Light weight, low transportation costs
- Reasonable structure design, easy installation and maintenance;

The luminous structure adopts SMD2835 LED+ round PC cover, large beam angle and uniform lighting;



LED LINEAR LIGHT-T85
ROUND VERSION

Suspension installation

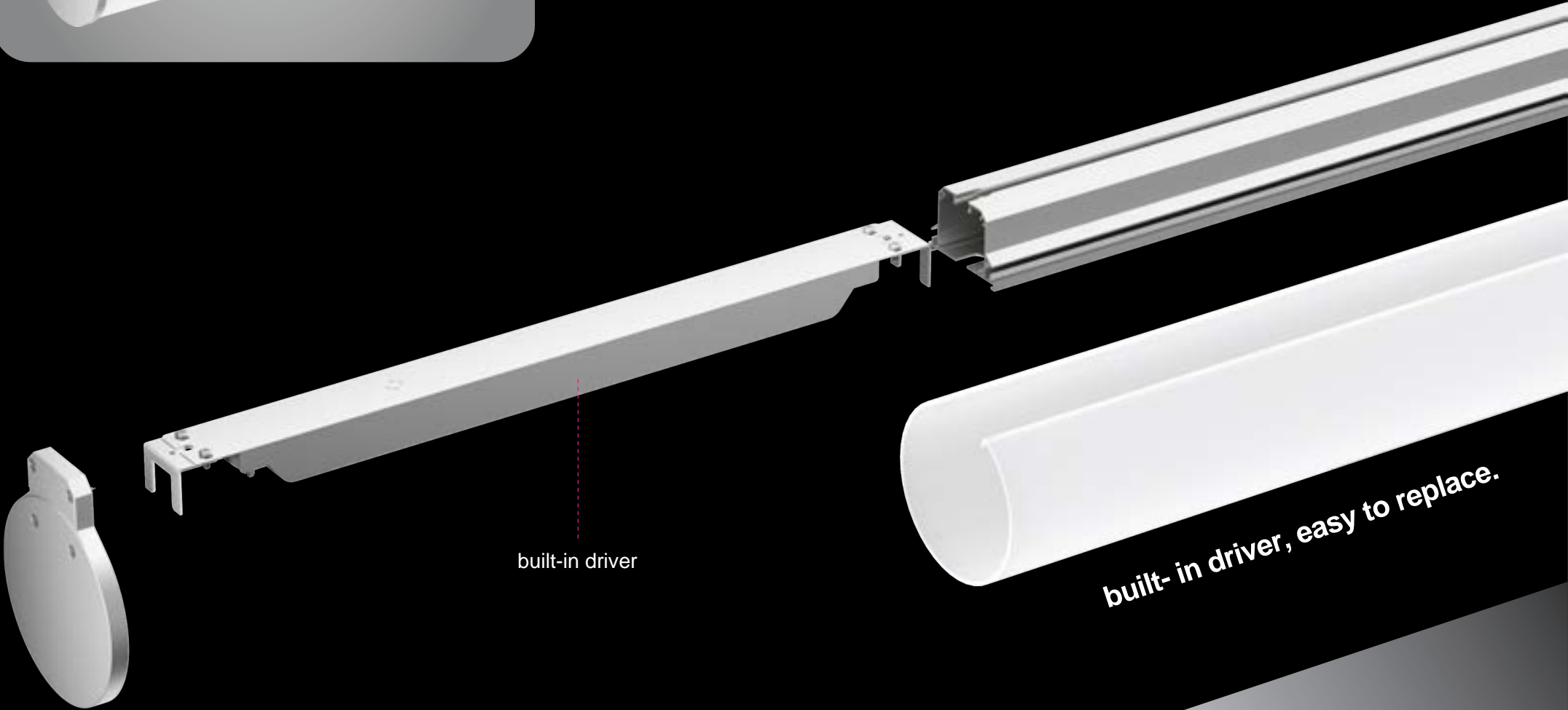

built-in driver

built-in driver, easy to replace.

Dimensions (mm)

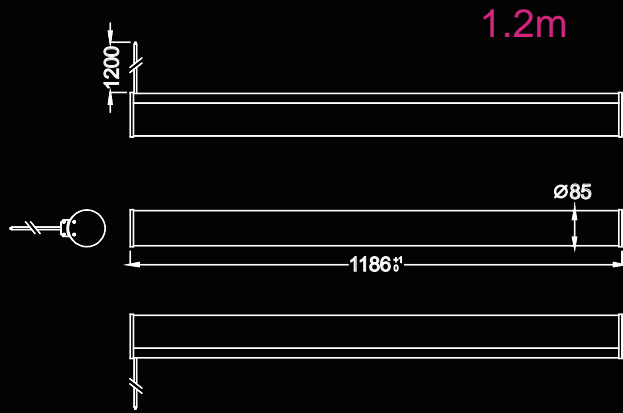

1.2m

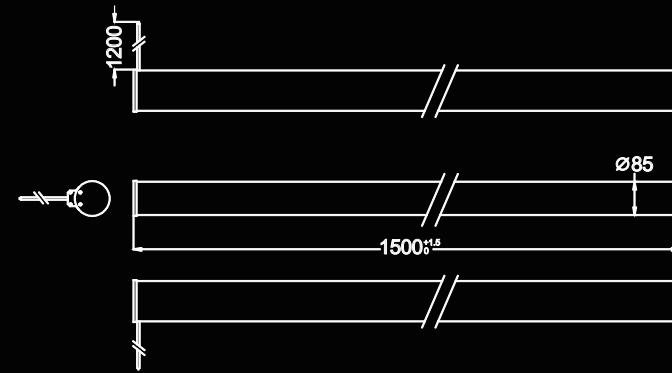
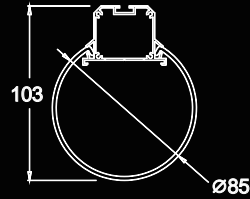

1.5m

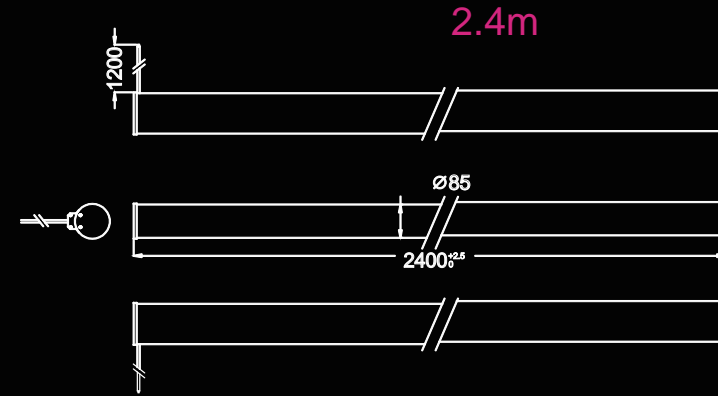
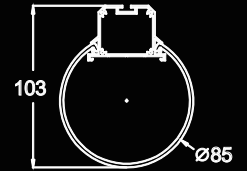

2.4m

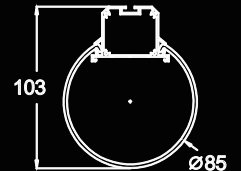

Parameter

Model	CCT	Luminous flux	POWER	Beam angle	IP grade	Input voltage	LED type	CRI	PF
SC-SL8585-036-AW-WW	2800-3200K	4100LM	36W	160°	IP40	200-240VAC/50/60HZ	2835	≥80	>0.9
SC-SL8585-036-AW-NW	3800-4200K	4520LM							
SC-SL8585-036-AW-CW	6000-6500K	4260LM							
SC-SL8585-045-AW-WW	2800-3200K	5130LM	45W	160°	IP40	200-240VAC/50/60HZ	2835	≥80	>0.9
SC-SL8585-045-AW-NW	3800-4200K	5625LM							
SC-SL8585-045-AW-CW	6000-6500K	5310LM							
SC-SL8585-072-AW-WW	2800-3200K	8200LM	72W	160°	IP40	200-240VAC/50/60HZ	2835	≥80	>0.9
SC-SL8585-072-AW-NW	3800-4200K	9000LM							
SC-SL8585-072-AW-CW	6000-6500K	8500LM							

Installation method

Explosive view of suspension installation

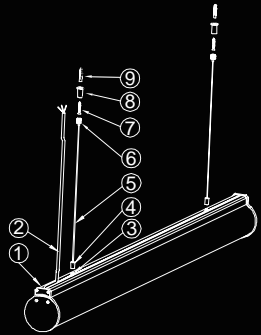

BOM

1. T85 lamp 1PCS
2. AC input wire 1PCS
3. Square head screw 2PCS
4. Fixing head 1 2PCS
5. Lifting rope 2PCS
6. Wire locker 2PCS
7. Screw 2PCS
8. Fixing head 2 2PCS
9. Rubber plug 2PCS

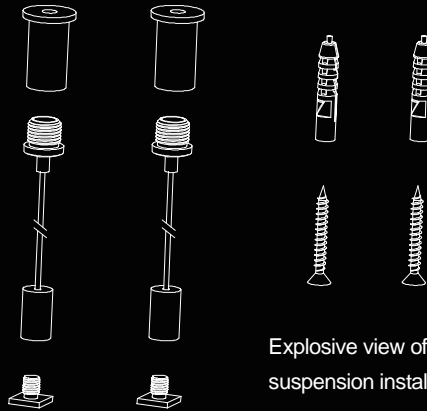

Explosive view of suspension installation



Explosive view of suspension installation

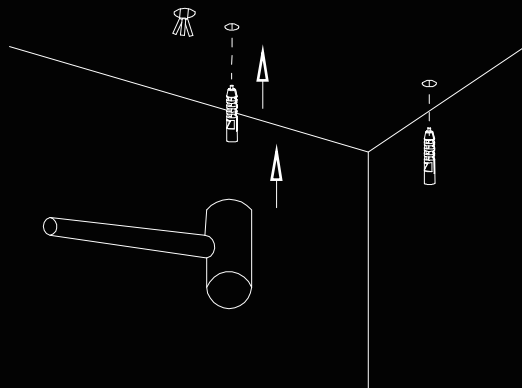

1. Drill two $\Phi 3.0\text{MM}$ and one $\Phi 7.0\text{M}$ round holes in the concrete ceiling according to the hole spacing as planned in the above diagram, and use a hammer to tap the rubber plug into the two $\Phi 3.0\text{MM}$ round holes and lead the AC input wire from the ceiling.

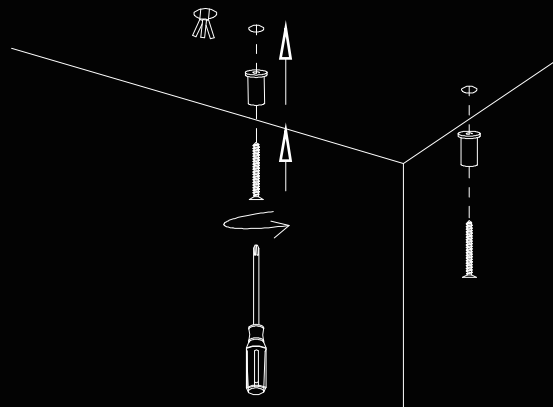

2. Thread the screw through the fixing head 2 and lock the fixing head 2 in the rubber plug with a cross screwdriver.

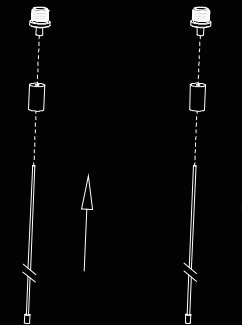

3. Pass the lifting rope through the fixing head 1 and wire locker in turn.

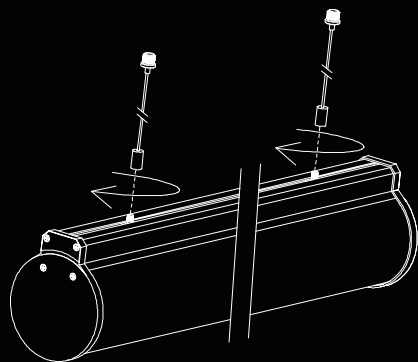

4. Tighten the square head screw in the lamp groove with the fixing head 1.

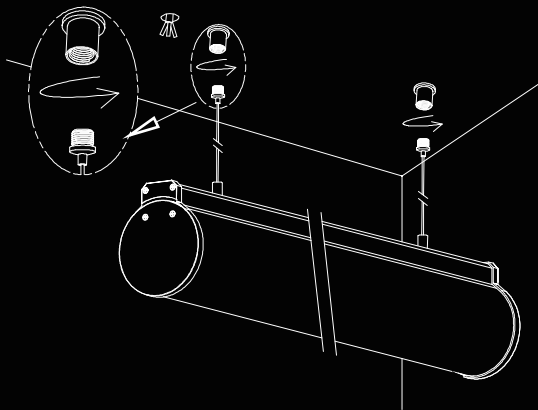

5. Tighten the wire locker and the fixing head 2.

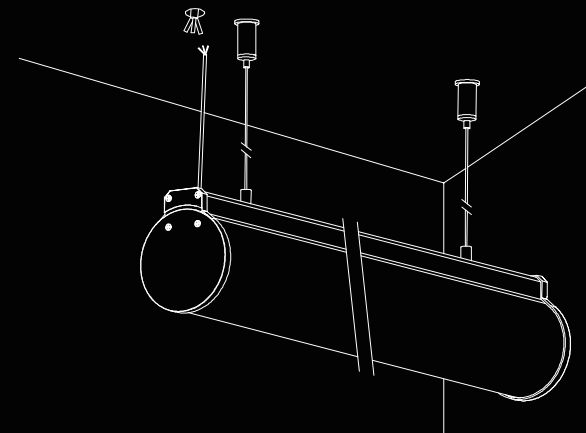

6. Connect the L, N and GND poles of the AC input wire on the ceiling to the L, N and GND poles of the AC input wire of the lamp, light up the lamp and the installation is completed.

Packaging

Model	Single lamp net weight	Net weight of 1 meter long lifting accessories	Inner box size(mm)	Inner box weight	Gross weight of each inner box (includes lifting accessories)	Carton size(mm)	Carton weight	Gross weight per carton lifted	QTY Number of cartons	Note
SC-SL8585-036-AW-WW	1.735kg	0.060kg	1236*157*139MM	0.385kg	2.18kg	1250*654*296MM	2.025kg	19.47kg	8pcs	1.2M T85 PC cover
SC-SL8585-036-AW-NW										
SC-SL8585-036-AW-CW										
SC-SL8585-045-AW-WW	2.2kg	0.060kg	1550*157*139MM	0.49kg	2.75kg	1564*654*296MM	2.54kg	24.54kg	8pcs	1.5M T85 PC cover
SC-SL8585-045-AW-NW										
SC-SL8585-045-AW-CW										
SC-SL8585-072-AW-WW	3.5kg	0.060kg	2450*157*139MM	0.77kg	4.33kg	2464*334*296MM	2.1kg	19.42kg	4pcs	2.4M T85 PC cover
SC-SL8585-072-AW-NW										
SC-SL8585-072-AW-CW										