

SIGNCOMPLEX LIMITED

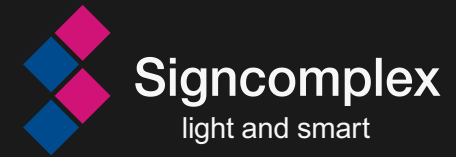

# Plant Grow Lighting

- +86 755 2760 8650
- [www.signcomplex.com](http://www.signcomplex.com)
- [marketing@signcomplex.com](mailto:marketing@signcomplex.com)

SIGNCOMPLEX LIMITED

**Grow**

your business

with

LED grow lights

# ABOUT SIGNCOMPLEX





 Founded in 2006

 Factory area 50,000m<sup>2</sup>

 700+ employees

 Main products  
LED smart lighting  
Plant grow lighting

 Certified systems  
ISO9001:2015 quality system  
ISO14001 environmental system

 Product certification  
CE/RoHS/ERP/UL/  
DLC/UKCA, etc.

 Market share  
Europe 40%/ North America 37%/  
China 8%/ other 15%

 National high-tech enterprise

 200+ patents

 Customized service

# BUSINESS ADVANTAGE



## Self-R&D

Our R&D and engineering team with over 100 people has rich experience in shape design, electronic structure, optical design, light control system and process improvement, etc. OEM/ODM services is available.



## Self-manufacture

Large factory area, professional production line for plant lighting products, sufficient production capacity.



## Professional supply chain management system

The products have characteristics and high cost performance.



## Professional service team

We have professional sales, technical support, quality control and logistics team to provide thoughtful service to our customers.



# CORPORATE CULTURE



## Value

Customer and quality first, real-time service, teamwork and continuous innovation.



## Business philosophy

Pragmatic, efficient, trustworthy and value-added.



## Vision

Global famous brand of intelligent lighting Century enterprise.



## Mission

Continuously improve products and services to meet customer needs  
Continuously innovate technology to create an intelligent and excellent light environment.

## Customized Service

Customize a wide range of LED plant grow light solutions according to specific varieties, growth stages and cultivation environment



Spectrum design



Product appearance design

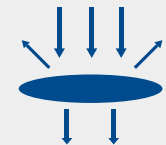

Optical design

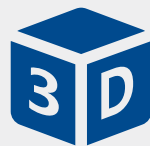

Structure Design



Control mode



Installation method

# IMPROVES YOUR CROP



01

Complete control over the plant growth process

02

Better crop quality and uniformity

03

Higher yield

04

More plants in the same space

05

Higher germination, rooting and multiplication factor

# EXPLORE MORE

## Vertical farming

Maximise indoor single or multi-layer yield planting. LED grow light can help you get a bigger harvest in a smaller space.



## Greenhouse

LED lighting can achieve higher light levels and vegetables can grow healthy even without sunlight. Signcomplex lighting solution can provide you with a competitive advantage.



## Floriculture

LED growth light can control all growth stages of flowers and indoor climate. Improve the reproductive success of flowers, obtain larger flowers and higher yield.



## Vegetable and fruit

Stronger plants, higher fruit weights and more uniform growth. LED indoor plant grow light can help growers obtain fruits of great colour, shape and flavour.



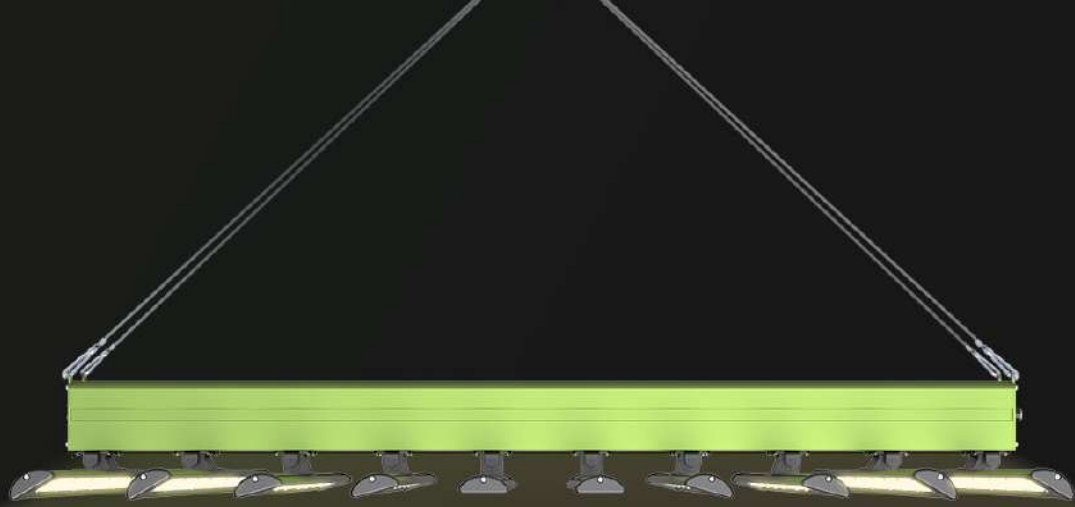

# GLB Series

640W | 720W | 1000W

**2.7**  $\mu\text{mol}/\text{J}$   
Efficacy

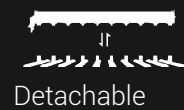

Detachable

**5** YEARS  
Warranty



## Plug&Play design

Shrapnel automatic electrical connection, no need to manually connect the plug wire, simple and efficient installation and maintenance.



## Removable

The product is detachable, not requiring tools to replace the light source module.



## Adjustable Angle



The adjustable angle of each light source module is  $\pm 30^\circ$ , which is convenient for customers to adjust the secondary light distribution, increase the effective irradiation area and PPFD, and improve the utilization efficiency of the light source.



## Brightness adjustable

Light intensity can be adjusted according to the growth needs of plants in different periods. OFF-25%-50%-70%-100%-EXT.

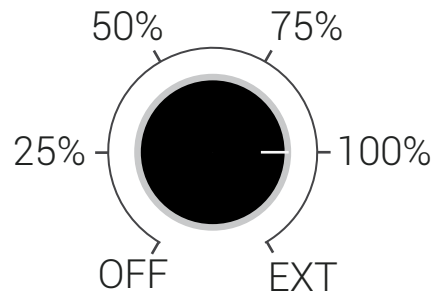

## Automatic control

The main controller can be connected to the external main controller to set the switching time and 0-100% dimming every day.

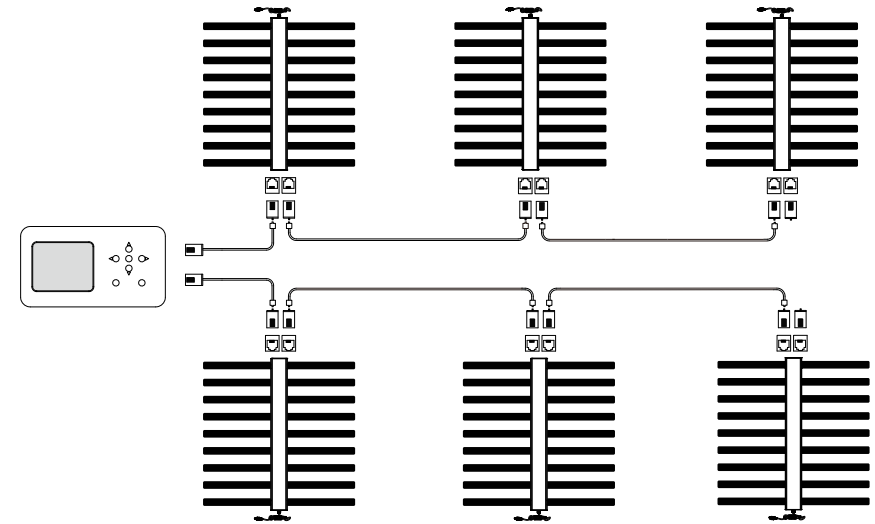

## High PPFD & Better Efficiency

Can generate light that has the highest energy efficiency (2.7  $\mu\text{mol}/\text{J}$ ) but only consumes 100 watts. It can increase your yields by 30% while saving your electricity bills.

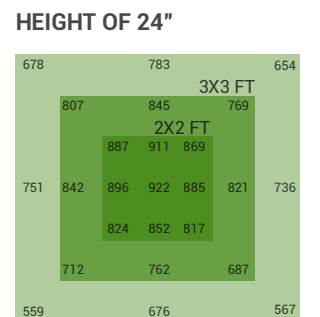
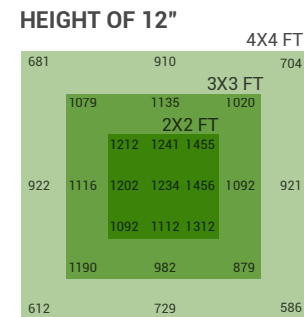

**640W PPFD Parameter**

## Spectrum

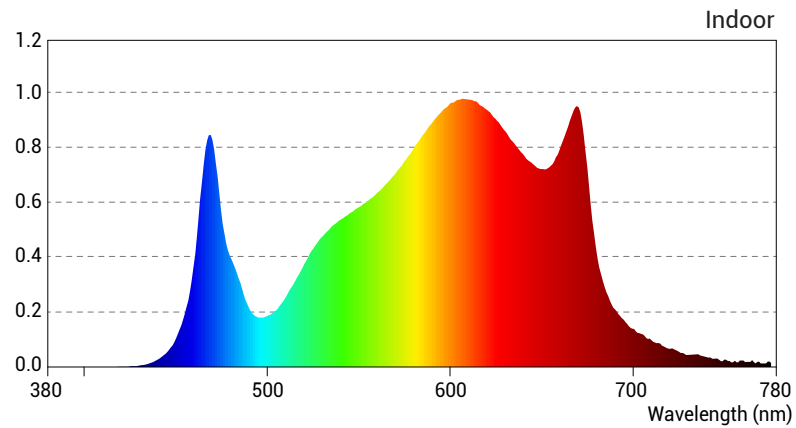

## Dimension

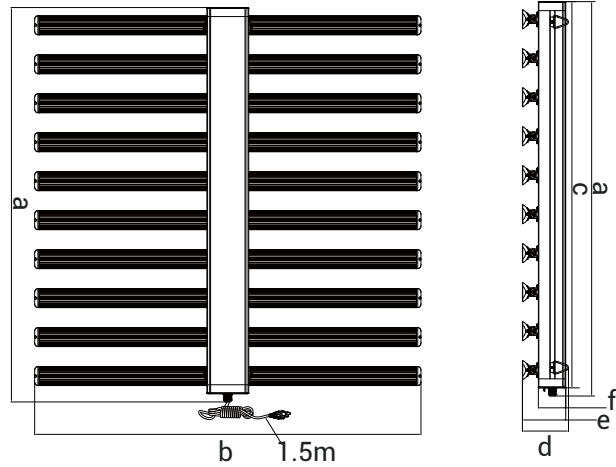

Power	a	b	c	d	e	f
640W/720W/1000W	1225.0 mm 48.23 inch	1200.0 mm 47.24 inch	1200.0 mm 47.24 inch	143.0mm 5.63 inch	134.5 mm 5.30 inch	85.0 mm 3.35 inch

## Parameters

### Ordinary Series

Model	Light Output PPF	Efficacy	AC Input Power	AC Input Voltage
GLB-640-AW-TWL-D02	1530±50 μmol/s	2.4 μmol/J @ 277 AC	635W @ 277V AC	120-277V AC, 50/60Hz
GLB-720-AW-TWL-D02	1720±50 μmol/s	2.4 μmol/J @ 277 AC	715W @ 277V AC	120-277V AC, 50/60Hz
GLB-1000-AW-TWL-D02	2400±100 μmol/s	2.4 μmol/J @ 277 AC	985W @ 277V AC	200-277V AC, 50/60Hz

### High Efficacy Series

Model	Light Output PPF	Efficacy	AC Input Power	AC Input Voltage
GLB-640-AW-TWL-DH02	1720±50 μmol/s	2.7 μmol/J @ 277 AC	635W @ 277V AC	120-277V AC, 50/60Hz
GLB-720-AW-TWL-DH02	1940±50 μmol/s	2.7 μmol/J @ 277 AC	715W @ 277V AC	120-277V AC, 50/60Hz
GLB-1000-AW-TWL-DH02	2700±100 μmol/s	2.7 μmol/J @ 277 AC	985W @ 277V AC	200-277V AC, 50/60Hz

### Other Parameters

Light Distribution:	120°
Mounting Height:	6"- 12" (15.2-30.5cm)Above Canopy
Thermal Management:	Passive
Max. Ambient Temperature:	95°F / 35°C
Dimming:	10 V-Source
Total Harmonic Distortion(THD):	< 10%
Lifespan:	L90: > 50,000hrs





# GLH Series

640W | 720W | 1000W

The GLH Series are electronic horticultural LED fixture with 6/8/9 LED light bars to be used in greenhouses or in climate-controlled rooms.

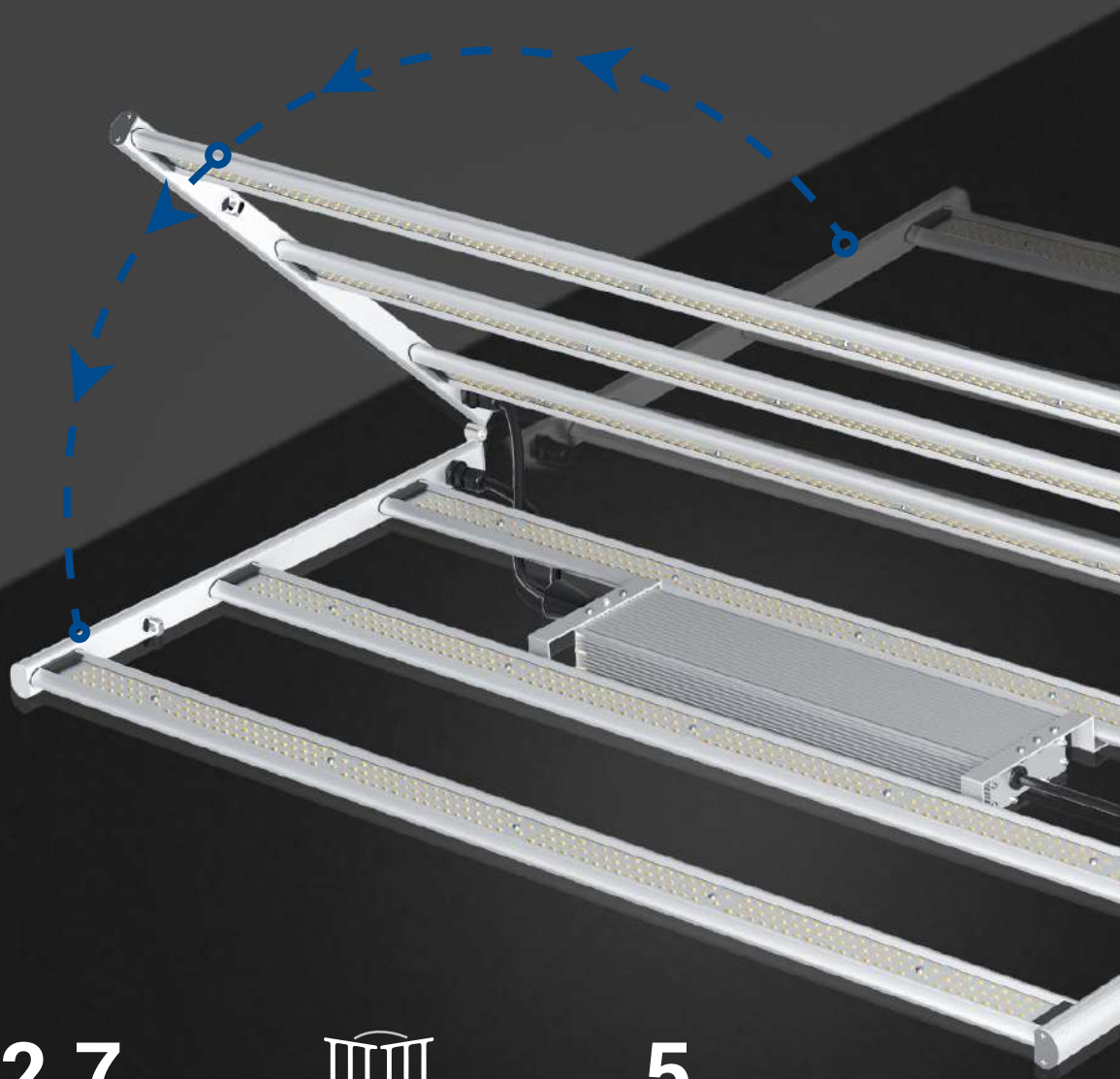

**2.7**  $\mu\text{mol}/\text{J}$   
Efficacy

  
180° Foldable

**5** YEARS  
Warranty

## Foldable

180° foldable slim design, making it small, compact, and easy to install.

## Saving costs

Power supply is not required to be installed, improving lamp installation efficiency.

### Saving 20% freight

GLH series Other



PCS

PCS



## Spectrum

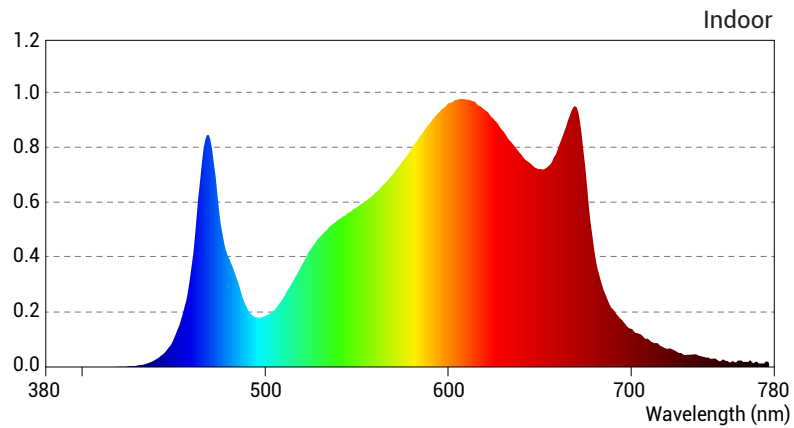

## Dimension

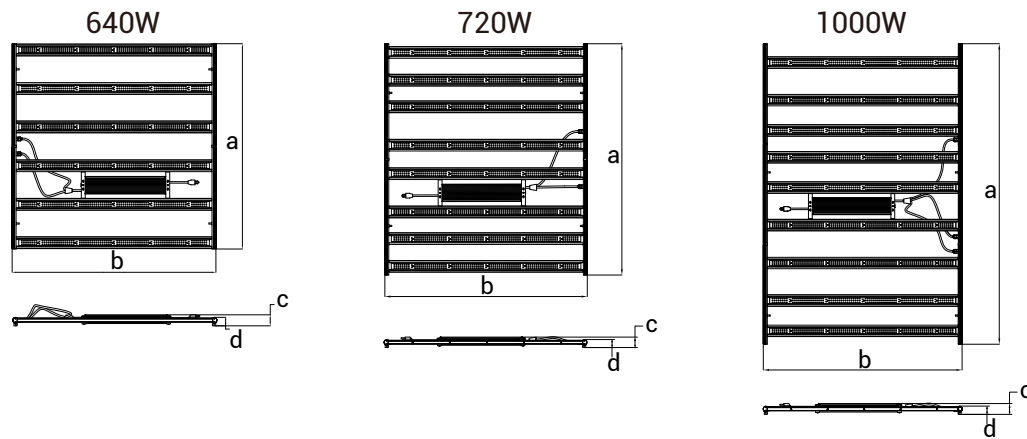

Power	a	b	c	d
640W	1051 mm 41.38 inch	1043 mm 41.06 inch	56 mm 2.20 inch	43 mm 1.69 inch
720W	1192 mm 46.92 inch	1043 mm 41.06 inch	56 mm 2.20 inch	43 mm 1.69 inch
1000W	1576 mm 62.04 inch	1043 mm 41.06 inch	56 mm 2.20 inch	43 mm 1.69 inch

## Parameters

### Ordinary Series

Model	Light Output PPF	Efficacy	AC Input Power	AC Input Voltage
GLH-640-AW-TWL-D02	1530±50 μmol/s	2.4 μmol/J @ 277 AC	635W @ 277V AC	120-277V AC, 50/60Hz
GLH-720-AW-TWL-D02	1720±50 μmol/s	2.4 μmol/J @ 277 AC	715W @ 277V AC	120-277V AC, 50/60Hz
GLH-1000-AW-TWL-D02	2400±100 μmol/s	2.4 μmol/J @ 277 AC	985W @ 277V AC	200-277V AC, 50/60Hz

### High Efficacy Series

Model	Light Output PPF	Efficacy	AC Input Power	AC Input Voltage
GLH-640-AW-TWL-DH02	1720±50 μmol/s	2.7 μmol/J @ 277 AC	635W @ 277V AC	120-277V AC, 50/60Hz
GLH-720-AW-TWL-DH02	1940±50 μmol/s	2.7 μmol/J @ 277 AC	715W @ 277V AC	120-277V AC, 50/60Hz
GLH-1000-AW-TWL-DH02	2700±100 μmol/s	2.7 μmol/J @ 277 AC	985W @ 277V AC	200-277V AC, 50/60Hz

### Other Parameters

Light Distribution:	120°
Mounting Height:	6"- 12" (15.2-30.5cm)Above Canopy
Thermal Management:	Passive
Max. Ambient Temperature:	95°F / 35°C
Dimming:	10 V-Source
Total Harmonic Distortion(THD):	< 10%
Lifespan:	L90: > 50,000hrs



# GLH3 Series

The GLH Series are electronic horticultural LED fixture with 6/9 LED light bars to be used in greenhouses or in climate-controlled rooms.

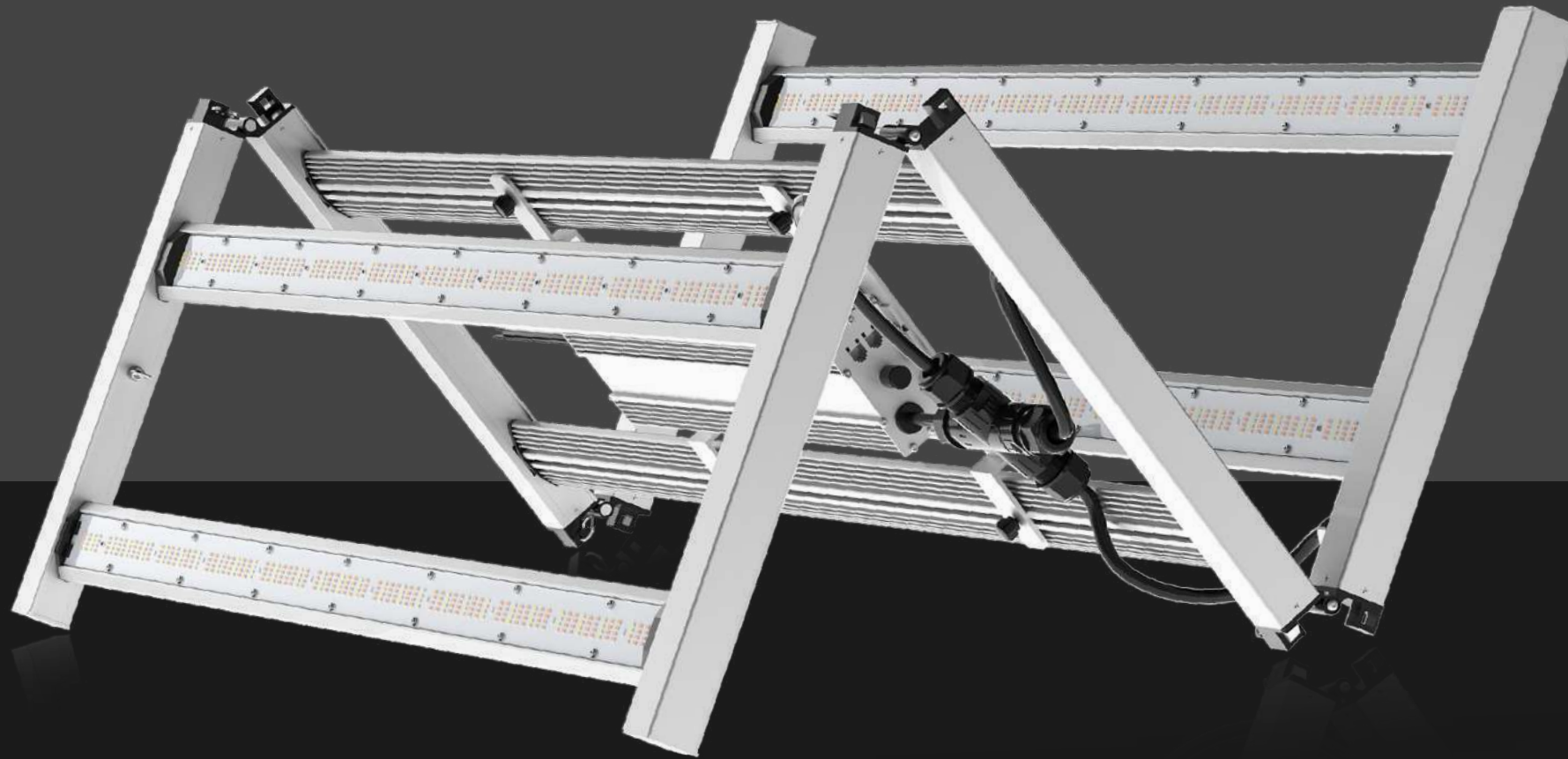

**2.7**  $\mu\text{mol}/\text{J}$   
Efficacy



Tri-fold



Damp Location



0-10V Dimming

**5** YEARS  
Warranty

**>54000** hours  
Lifespan

## Z-shaped folding design

The folding part adopts thimble design, which can be automatically locked when unfolded 180°, making it easy to install and more stable.

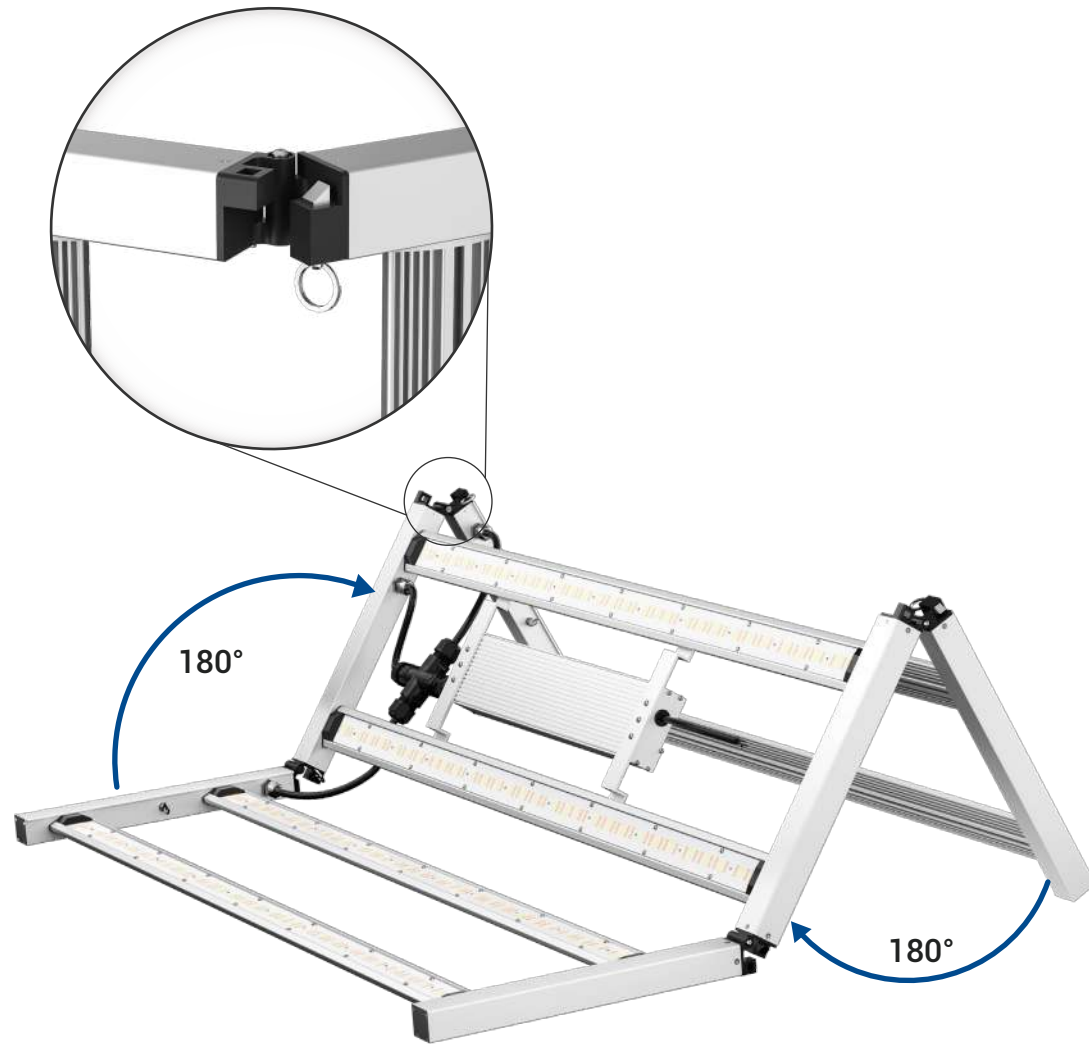

## Brightness adjustable

Light intensity can be adjusted according to the growth needs of plants in different periods. OFF-25%-50%-70%-100%-EXT.  
The main controller can be connected to the external main controller to set the switching time and 0-100% dimming every day.



## Saving installation costs

The power supply is fixed on the heat sink without subsequent installation of the power supply.

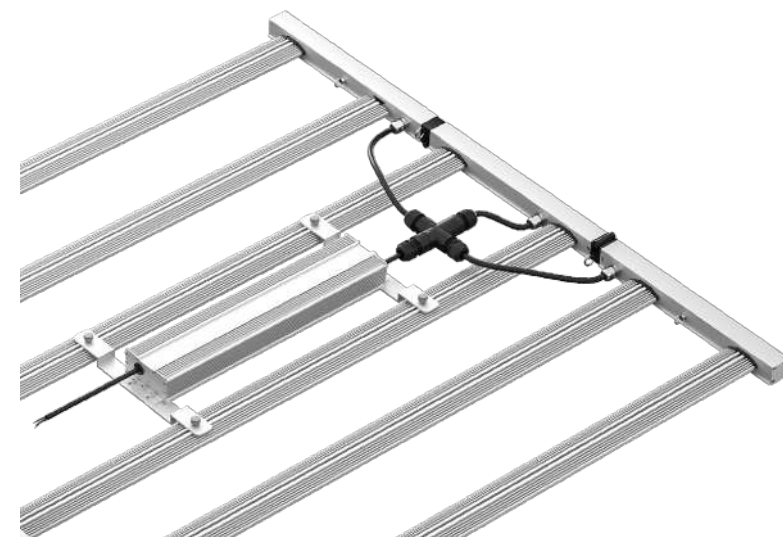

## Spectrum

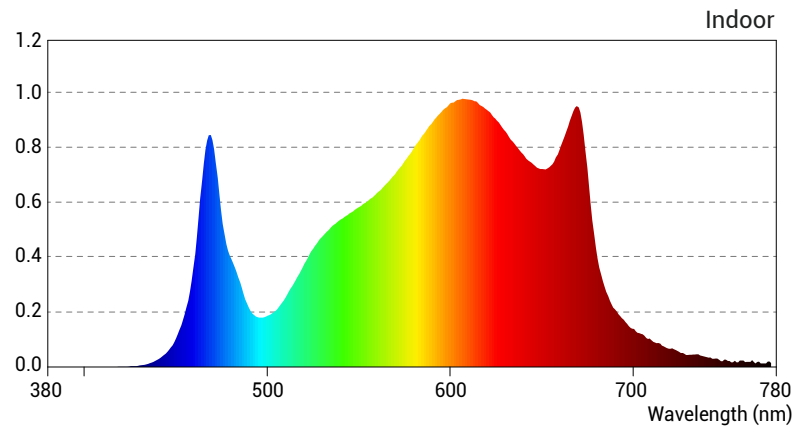

## Dimension

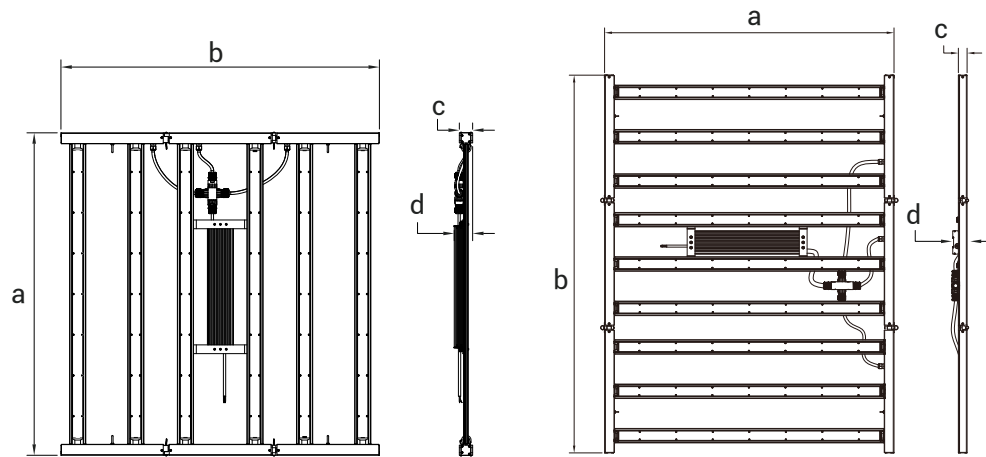

Power	a	b	c	d
640W/720W	1110.0 mm 43.70 inch	1100.0 mm 43.30 inch	45.0 mm 2.48 inch	63.0mm 1.77 inch
1000W	1110.0 mm 43.70 inch	1605.0 mm 63.18 inch	33.3 mm 1.31 inch	55.0mm 2.16 inch

## Parameters

### Ordinary Series

Model	Light Output PPF	Efficacy	AC Input Power	AC Input Voltage
GLH3-640-AW-TWL-D02	1530±50 μmol/s	2.4 μmol/J @ 277 AC	635W @ 277V AC	120-277V AC, 50/60Hz
GLH3-720-AW-TWL-D02	1720±50 μmol/s	2.4 μmol/J @ 277 AC	715W @ 277V AC	120-277V AC, 50/60Hz
GLH3-1000-AW-TWL-D02	2400±100 μmol/s	2.4 μmol/J @ 277 AC	985W @ 277V AC	200-277V AC, 50/60Hz

### High Efficacy Series

Model	Light Output PPF	Efficacy	AC Input Power	AC Input Voltage
GLH3-640-AW-TWL-DH02	1720±50 μmol/s	2.7 μmol/J @ 277 AC	635W @ 277V AC	120-277V AC, 50/60Hz
GLH3-720-AW-TWL-DH02	1940±50 μmol/s	2.7 μmol/J @ 277 AC	715W @ 277V AC	120-277V AC, 50/60Hz
GLH3-1000-AW-TWL-DH02	2700±100 μmol/s	2.7 μmol/J @ 277 AC	985W @ 277V AC	200-277V AC, 50/60Hz

### Other Parameters

Light Distribution:	120°
Mounting Height:	6"- 12" (15.2-30.5cm)Above Canopy
Thermal Management:	Passive
Max. Ambient Temperature:	95°F / 35°C
Dimming:	10 V-Source
Total Harmonic Distortion(THD):	< 10%
Lifespan:	L90: > 50,000hrs



# QCD Series



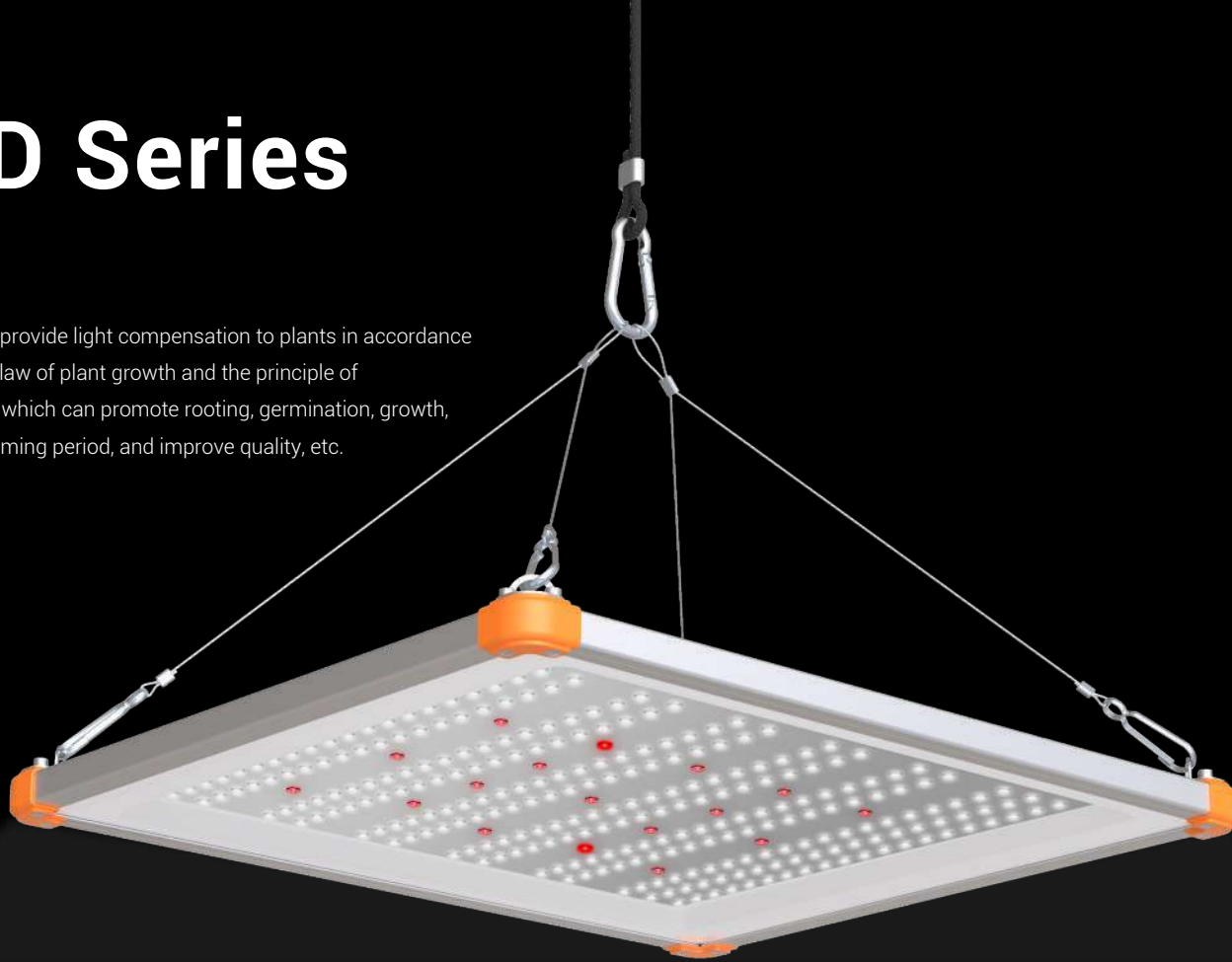

The QCD Series provide light compensation to plants in accordance with the natural law of plant growth and the principle of photosynthesis, which can promote rooting, germination, growth, prolong the blooming period, and improve quality, etc.

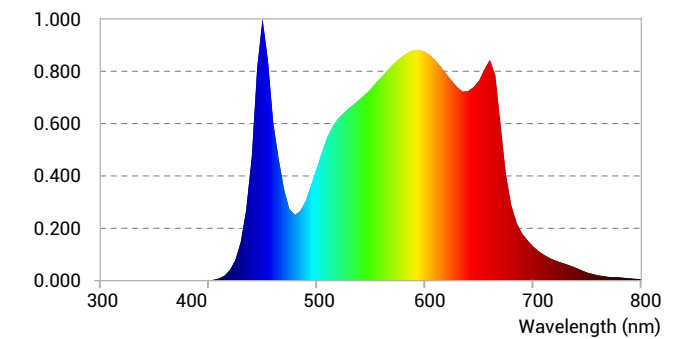

## Sunlike full spectrum

Its spectral range is 380-780nm. This full spectrum required by plants can provide plants with natural light from seedling to flowering and fruiting.



-  Full-spectrum
-  High light efficiency
-  Slim design
-  Good heat dissipation
-  Easy installation

## Professional plant LEDs

This product uses the latest SMD LED technology, which provides high PAR Output, high energy efficiency of 2.0  $\mu\text{mol}/\text{J}$ , and improved light penetration.



## Dimension

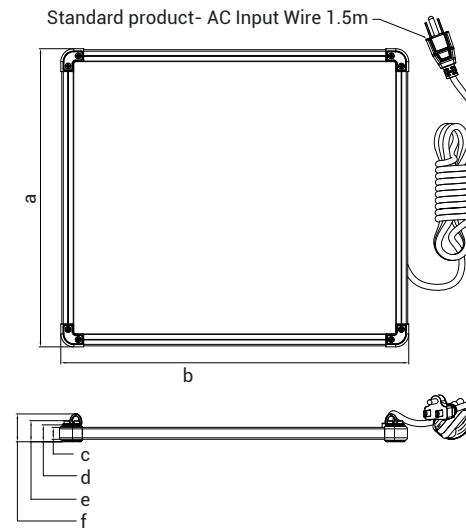

Power	a	b	c	d	e	f
100W	300.0 mm 11.81 inch	350.0 mm 13.78 inch	12.0 mm 0.47 inch	17.0mm 0.67 inch	21.5mm 0.85 inch	28.0 mm 1.10 inch

## Slim design

Slim design and easy handling.  
Saving 50% freight.



## Parameters

Model	Light Output PPF	Efficacy	Power (w)+10%	Voltage frequency	Replace
QCD-100-AL-TWL-101	190 $\mu\text{mol}/\text{s}$	1.8-2.0 $\mu\text{mol}/\text{J}$	100W	120V AC, 60Hz, 1.2A Max	150W HPS

# LED Plant Grow Light Kits

## -2835 Series

LED plant grow light strip provides light compensation to plants in accordance with the natural law of plant growth and the principle of photosynthesis, which can promote rooting, germination, growth, prolong the blooming period, and improve quality, etc.

Support 2-way, 4-way and 6-way connection.



## Full spectrum+660nm red light

Quality full spectrum LED and 660nm red light providing perfect spectrum to improve vegetable, fruit and floriculture crops.

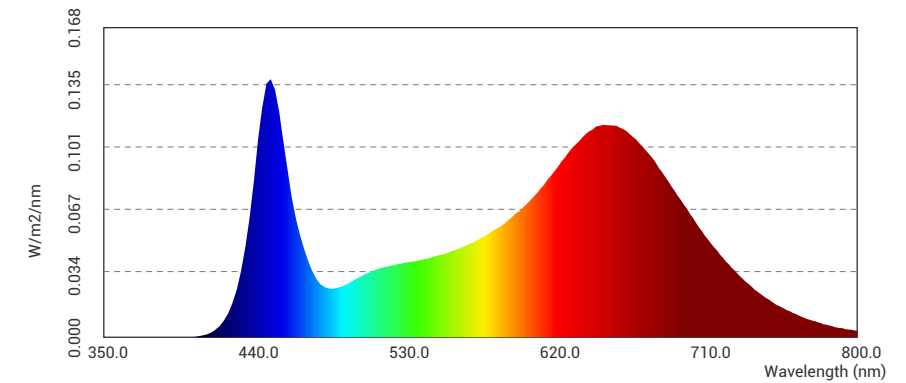

## 10 level brightness

10%-100% light photons touch stepless dimming, 4K refresh rate without flicker under camera shooting.

## Auto timing function

On/off and 3 types of timing setting to meet different daily cycle.





## Lighting uniformity

High quality plastic body with wave lens, no rust, no corrosion, uniform lighting.

## Easy to install

3 types of installation: clip, adhesive and tie.



## Dimension

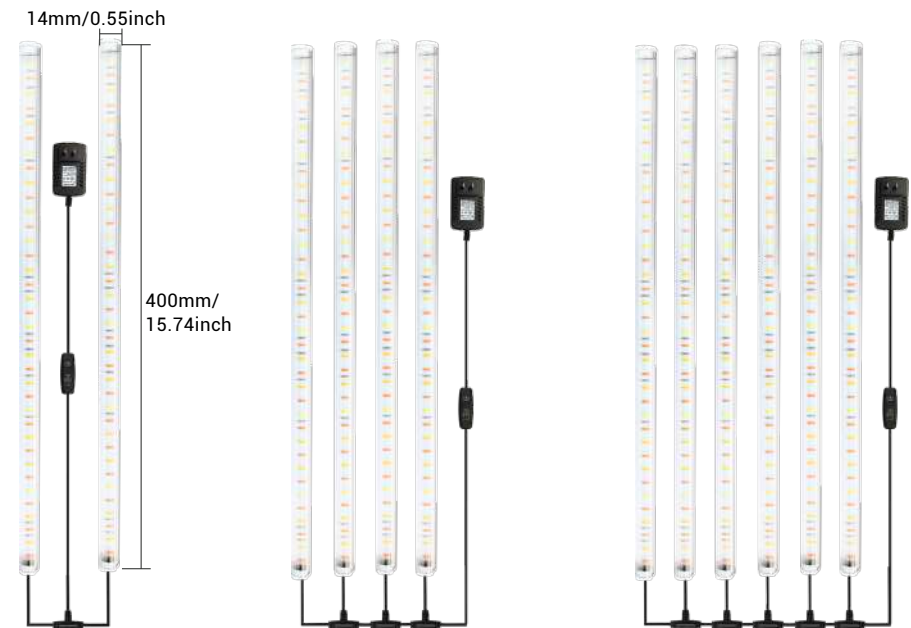

## Parameters

Model	Color	Lux (lx)	PPFD ( $\mu\text{mol}/\text{m}^2/\text{s}$ )	Power (W/PCS)	LED Qty.
2-way	R(660-665nm) W(6500K) WW(3000K)	3600	85	10	72
4-way	R(660-665nm) W(6500K) WW(3000K)	8000	190	20	144
6-way	R(660-665nm) W(6500K) WW(3000K)	11500	280	30	216



# LED Plant Grow Light Kits

## -3030 Series

LED plant grow light strip provides light compensation to plants in accordance with the natural law of plant growth and the principle of photosynthesis, which can promote rooting, germination, growth, prolong the blooming period, and improve quality, etc.

Support 2-way, 4-way and 6-way connection.



## Full spectrum+660nm red light

Spectrum LED and high quality SMD3030 package ,660nm red light. With Signcomplex professional LED grow lights, you can control many aspects of crop growth to get better business results.

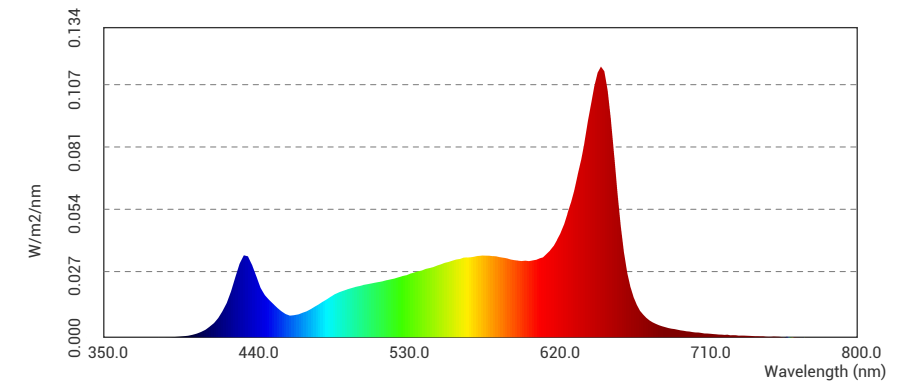

## 10 level brightness

10%-100% light photons touch stepless dimming, 4K refresh rate without flicker under camera shooting.

## Auto timing function

On/off and 3 types of timing setting to meet different daily cycle.



## Lighting uniformity

High quality plastic body with wave lens, no rust, no corrosion, uniform lighting.

## Easy to install

3 types of installation: clip, adhesive and tie.



## Dimension

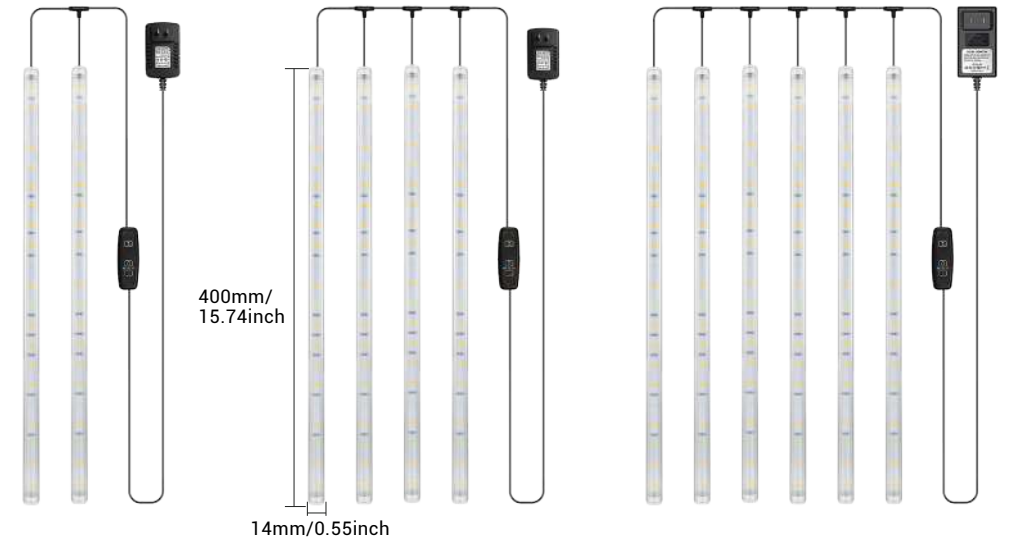

## Parameters

Model	Color	Lux (lx)	PPFD ( $\mu\text{mol}/\text{m}^2/\text{s}$ )	Power (W/PCS)	LED Qty.
2-way	R(660-665nm) W(6500K) WW(3000K)	3200	72	10	42
4-way	R(660-665nm) W(6500K) WW(3000K)	6500	130	20	84
6-way	R(660-665nm) W(6500K) WW(3000K)	8000	160	30	126



# LED Flexible Strips for Plant Lighting

Natural light often falls short on giving crops what they need to grow and flourish. With Signcomplex professional LED grow lights helping you produce vegetables, fruits or flowers – in a greenhouse, vertical farm or other indoor facility – we offer a choice of the best LED grow lights for your specific crop.



# Full spectrum

Quality full spectrum LED and 660nm red light provide perfect spectrum to improve vegetable, fruit and floriculture crops.

Signcomplex professional LED grow lights technology helps you control many aspects of crop growth to get better business results.

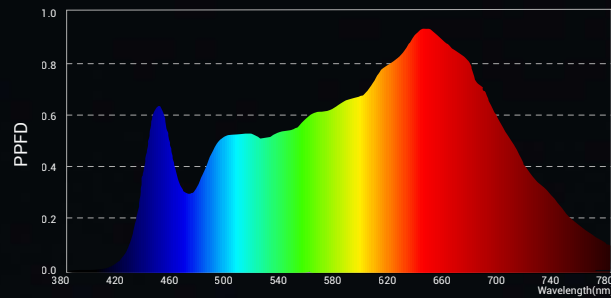

# Improve stretching process

Ideal for propagating young plants, cultivating leafy greens, herbs and fruits, and rapidly developing new varieties of seeds.

# IP65 waterproof

Fearless to splash and rain.

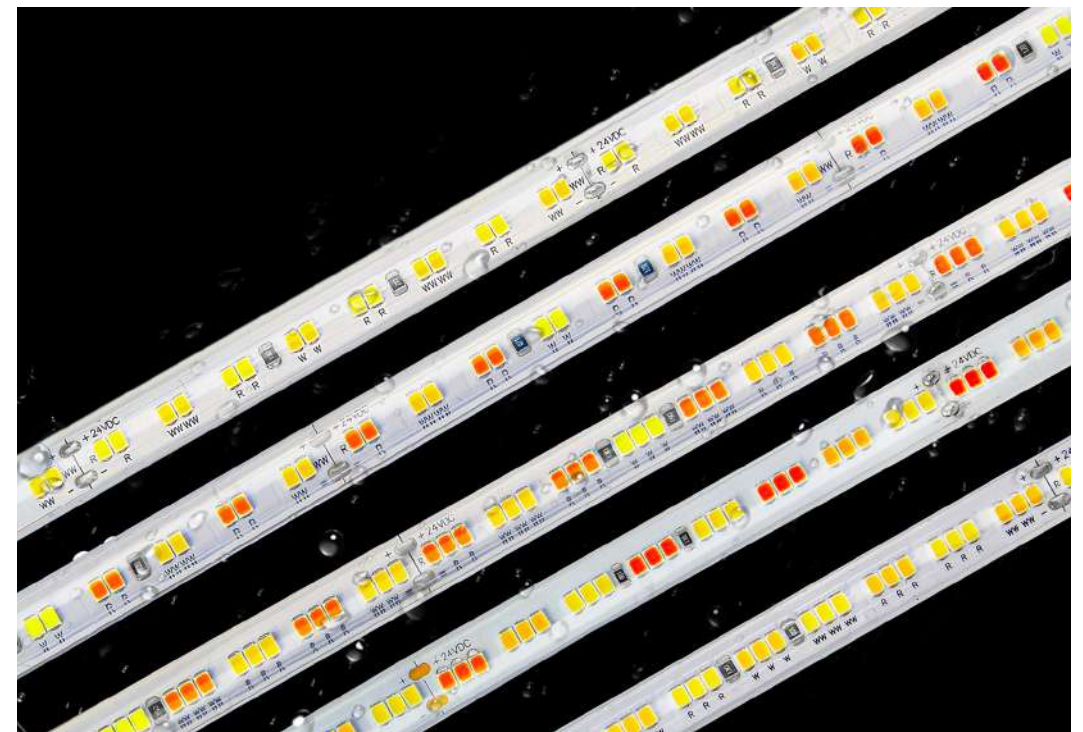

# Parameters

Model	Color	PPF (μmol/s)	PPFD (μmol/m <sup>2</sup> / s)	DLI (mol/m <sup>2</sup> )	LED Qty.
SC-2835PG-24D-R+TW-24	R(660-665nm) W(6500K)	31.3	172	14.9	240
SC-2835PG-16D-R+TW-24	WW(3000K)	30	156	13.5	160
SC-2835PG-24D-R+TM-24	R(660-665nm) W(6500K @full spectrum)	33	162	12.6	240
SC-2835PG-24D-R+TM-24	WW(3000K)	31	158	12.2	160
SC-2835PG-24D-R+TM-24	W(6500K @full spectrum)	33.6	172	14.8	240
SC-2835PG-24D-R+TM-24	WW(3000K)	32.8	157	13.6	160
SC-2835PG-24D-RBWW-24	R(660-665nm) B( 455-460nm)	39.2	213	18.4	240
SC-2835PG-16D-RBWW-24	WW(3000K)	37.8	195	17.2	160

## Other Parameters

Power(w/m):	19.2
Beam angle:	120°
Voltage:	24
IP:	IP65

