

ARK8 SERIES

Seamless Lightbar

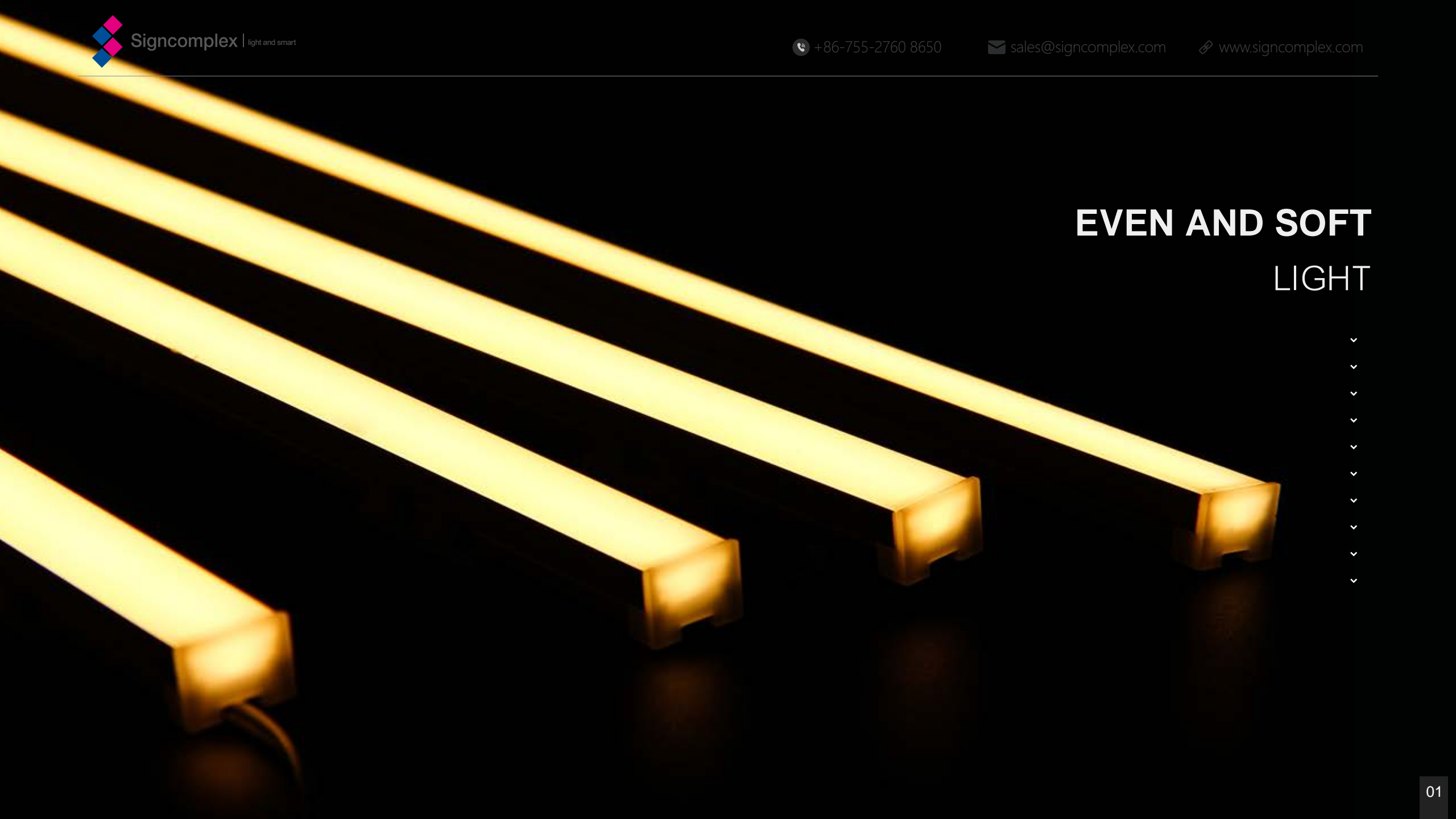



EVEN AND SOFT LIGHT

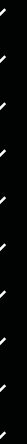

THE WHOLE SURFACE IS LUMINOUS

NO DARK AREA, NO FRAME

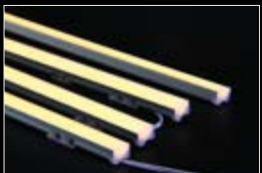
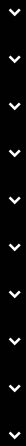

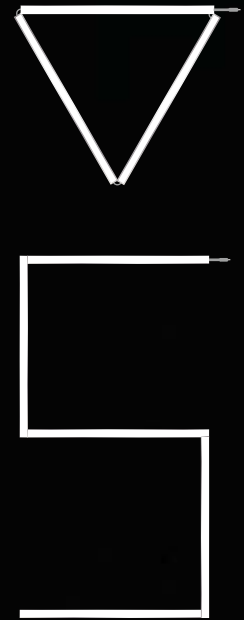

**CAN BE INTERCONNECTED
AND FREELY SPLICED**

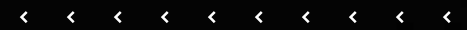

EASY TO SPLICE



The PCB contact pad is processed with immersion gold technology, while the terminal with electroplated gold technology, which enables the following advantages:

- › Good conductivity and greater stability after the PCB is connected to the terminal.
- › Long antioxidation time, strong corrosion resistance, and extended lifespan.

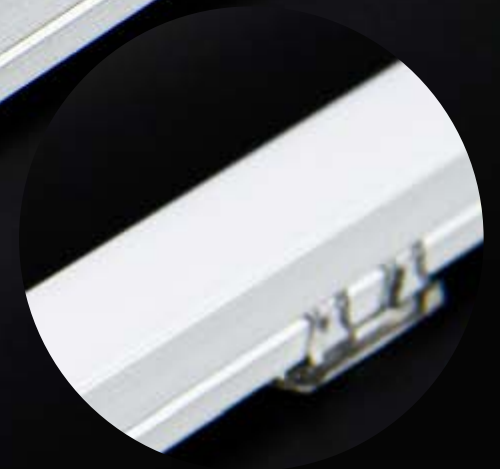

› › › › › › › **HIDDEN BUCKLE DESIGN**
MORE BEAUTIFUL PRODUCT, GOOD OVERALL EFFECT

SPECIFICATIONS

Model	Color	Lumen (lm/PCS)	LED Type	LED Qty. (LEDs/PCS)	Beam Angle (°)	DC Voltage (V)	Power (w/PCS)	CRI	IP
SC-ARK8-2835-XX-24-500	WW	240	2835	104	120	24	2.5	80	IP20
	NW	250							
	WW	260							
SC-ARK8-2835-HXX-24-500	W	510							
	NW	520							
	W	530							
SC-ARK8-2216-XX+XX-24-500	WW+W	260+300	2216	240	120	24	3.6+3.6	80	IP20

ACCESSORIES

Holder

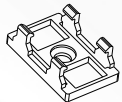

2PCS

SC-ARK-2835 Connector wire

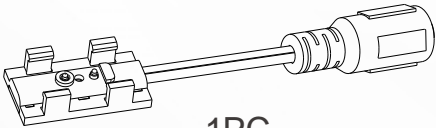

1PC

Screw

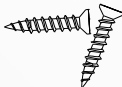

2PCS

SC-ARK-2216 Connector wire

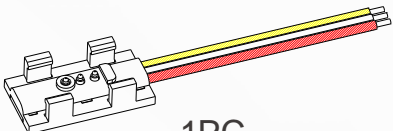

1PC

Middle connector wire

—

For LED strip splicing and interconnection

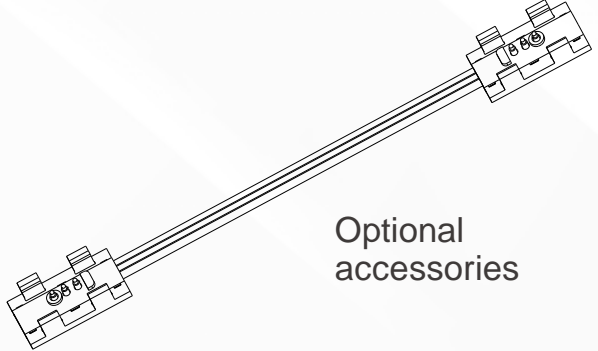

Optional accessories

Unit:mm/inch

SC-ARK8-2835

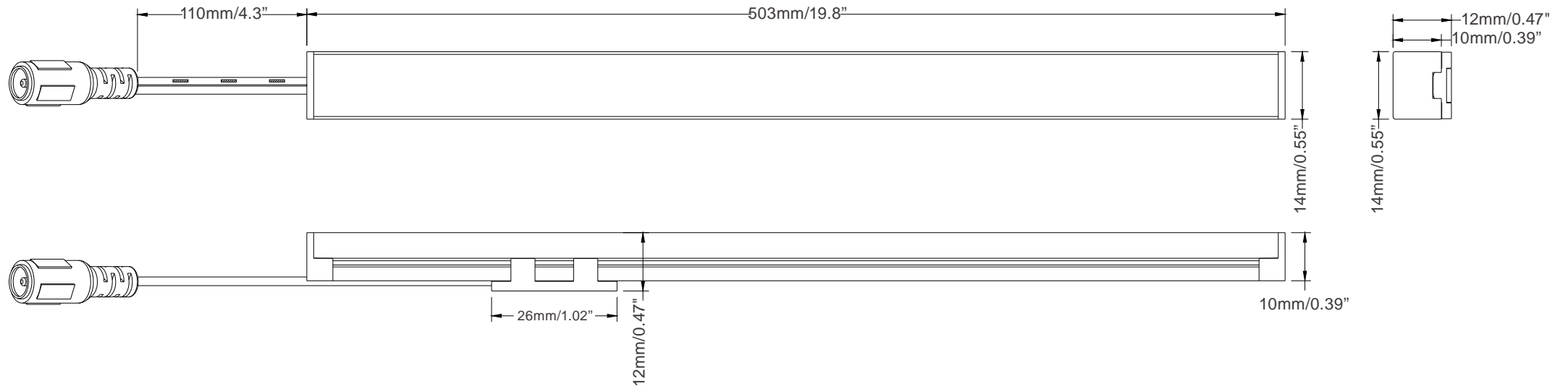

SC-ARK8-2216

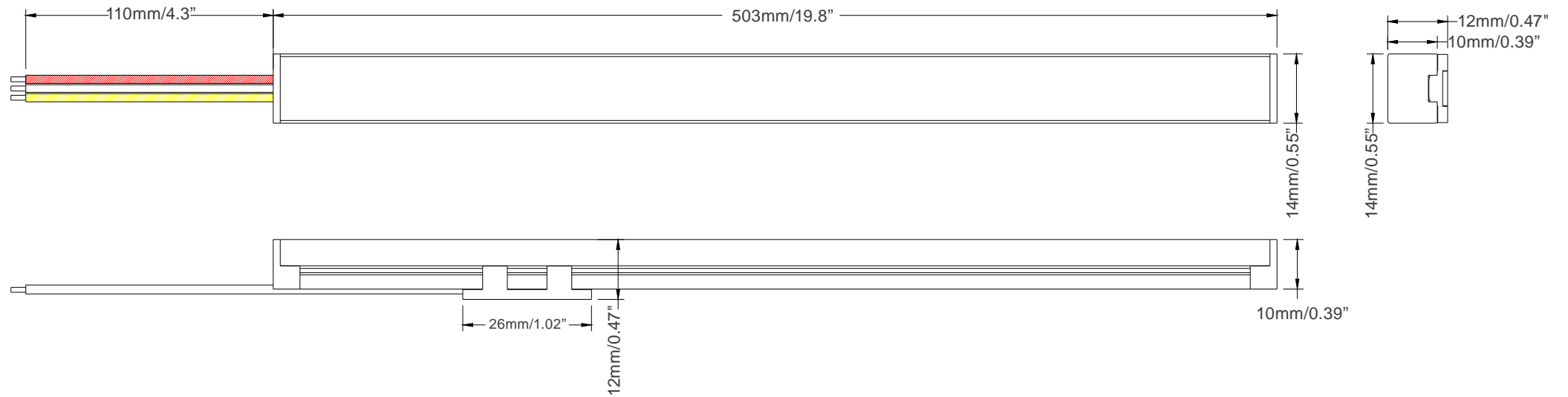

01

Clamp the power cable connector into the aluminium profile, aligning the cylinder on the connector with the semicircular opening at the back of the profile. The connector can be pressed into the profile and slid downward to ensure that the connector is fitted flat.

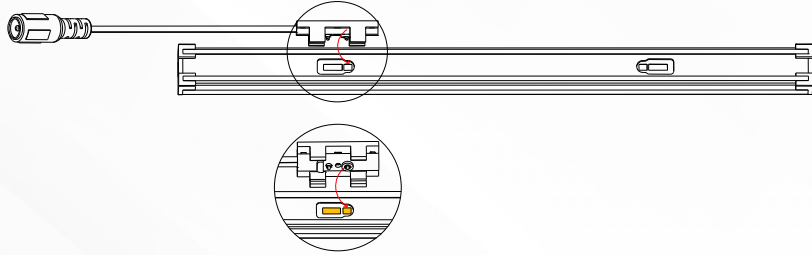

Align the cylinder on the connector with the semicircular opening on the back of the aluminum profile

02

If interconnection is required, the light strip shall be connected by the optional middle connector wire, as shown in the figure above. The longest interconnection is 5m or 10pcs.

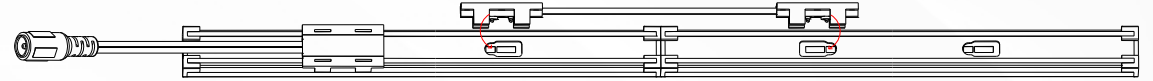

03

After the holder is fixed, clip the grooves on both sides of the bottom of the light strip into the holder. Different shapes can be spliced according to different requirements, such as triangle, square, etc.

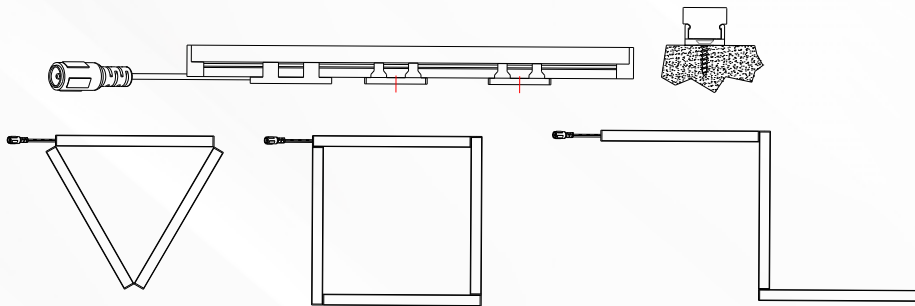

04

Finally connect the power supply, and the light strip connection is completed.

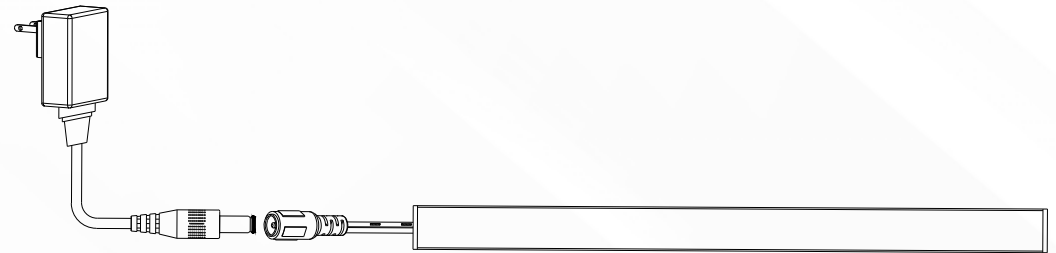

PACKAGING INFORMATION

Model	Carton packing box (pcs/carton)	Carton size (mm)	Weight (kg/carton)
SC-ARK8-2835-XX-24-500 SC-ARK8-2835-HXX-24-500	125	590*325*211mm	10KG
SC-ARK8-2216-XX+XX-24-500	125	590*325*211mm	10KG

INSTALLATION REQUIREMENT

1. The light strip and other accessories can not be pressed;
2. Do not damage the conducting wire of the circuit board during installation;
3. The installation of the light strip should be in accordance with the electrical safety standards.
Only professional personnel can install it;
4. Ensure that the power supply is loaded by transformer conversion;
5. Observe the polarity before installing, connect properly to prevent damage to the light strip;
6. Provide anti-corrosion environment for products;
7. Working temperature is -20°C~40°C.



Suitable for cabinets, exhibition racks, shelves, wardrobes, bookcases, etc.