

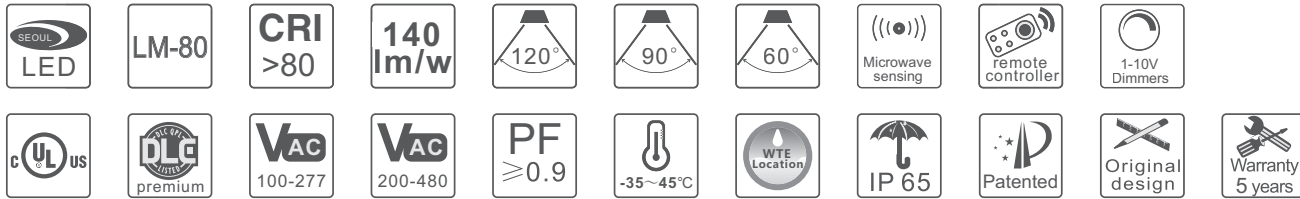

Cibay-S High Bay Light UL Type

CB-100/150/200/240/AW/HV-30K/35K/40K/50K-SZYY



Feature:

1. Built-in microwave sensor optional, do not need wiring, save labor time.
2. High temperature series optional, applicable to special environment in temperature no more than 60°C.
3. Adopt LED of high lighting effect, lighting effect of luminaire reaches up to 140LM/W.
4. Optical device with PC lens, IK08, anti UV.
5. CRI > 80, good color rendering performance.
6. LEDs are circularly arranged in symmetric, heat source are efficiently distributed in balance, high-efficient thermal conduction.
7. IP65 design.
8. Can operate in -35°C~+45°C environment.



Application

Suitable for large workshop, airport, warehouse, parking lot, basement, gymnasium ect.



Description

Cibay-S High Bay Light adopt built-in microwave sensor developed by Signcomplex, which adopts patent design and can save over 90% of labor time as it do not need wiring.

In the meanwhile, it reduces user inventory greatly. Using together with this intelligent microwave sensor, all traditional Cibay-S High Bay Light can realize both functions of motion sensing and light sensing.

Cibay-S High Bay Light can choose super high temperature series and maximum using environment temperature is 60°C, which is applicable to use in environment under particularly high temperature.

Three types of lens optional, 60°, 90°, 120°. End user can change as they like, convenient and practical.

Technical parameters

Model	CCT	Lumen(lm) ±10%	Beam (angle°) ±10%	LEDs type CRI	Power(w) ±10%	Voltage Frequency
CB-100-AW/HV-50K-SDYY/SSYY	5000k	13400	120°	SMD Ra > 80	100W	AW:100-277VAC HV:200-480VAC 50-60Hz
CB-100-AW/HV-40K-SDYY/SSYY	4000k	13270	90°			
CB-100-AW/HV-35K-SDYY/SSYY	3500k	12530	60°			
CB-100-AW/HV-30K-SDYY/SSYY	3000k	12300				
CB-150-AW/HV-50K-SDYY/SSYY	5000k	20190	120°	SMD Ra > 80	150W	AW:100-277VAC HV:200-480VAC 50-60Hz
CB-150-AW/HV-40K-SDYY/SSYY	4000k	19830	90°			
CB-150-AW/HV-35K-SDYY/SSYY	3500k	18840	60°			
CB-150-AW/HV-30K-SDYY/SSYY	3000k	18480				
CB-200-AW/HV-50K-SDYY/SSYY	5000k	27260	120°	SMD Ra > 80	200W	AW:100-277VAC HV:200-480VAC 50-60Hz
CB-200-AW/HV-40K-SDYY/SSYY	4000k	26840	90°			
CB-200-AW/HV-35K-SDYY/SSYY	3500k	25300	60°			
CB-200-AW/HV-30K-SDYY/SSYY	3000k	24810				
CB-240-AW/HV-50K-SDYY/SSYY	5000k	32340	120°	SMD Ra > 80	240W	AW:100-277VAC HV:200-480VAC 50-60Hz
CB-240-AW/HV-40K-SDYY/SSYY	4000k	32170	90°			
CB-240-AW/HV-35K-SDYY/SSYY	3500k	30400	60°			
CB-240-AW/HV-30K-SDYY/SSYY	3000k	29850				

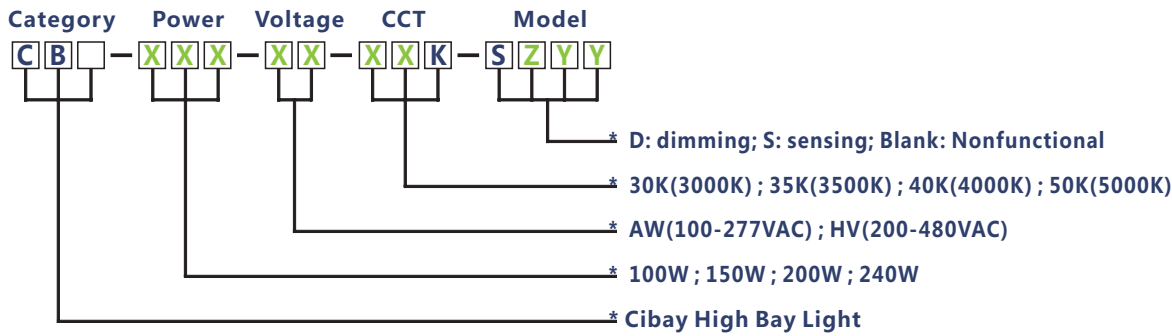

- * Traditional product can't be used outdoors
- * Suitable for damp environment, slight corrosion-proof grade indoors
- * "YY" maybe 00 TO 99.

Distribution Diagram

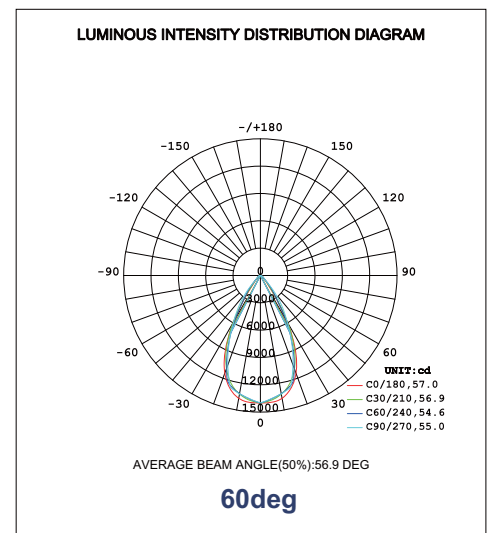
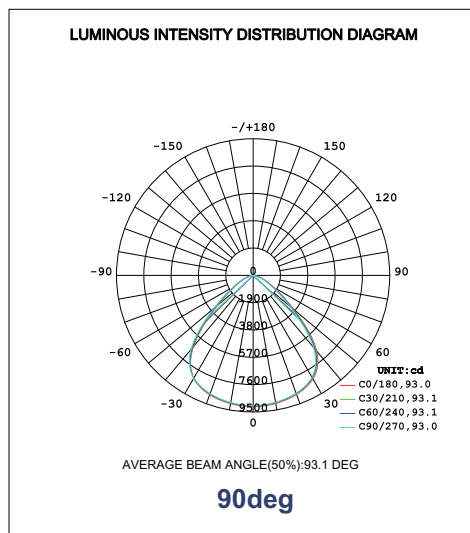
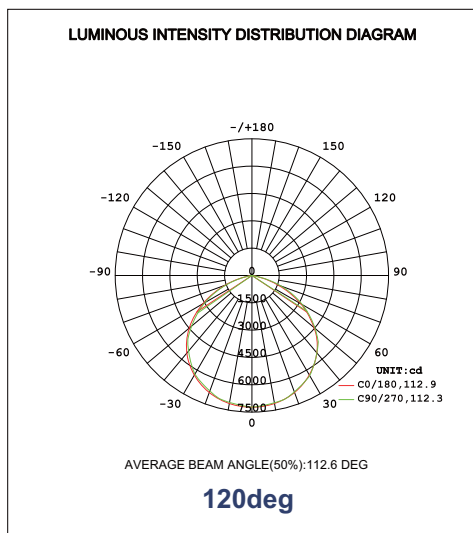

Dimension(Unit:mm/inch)

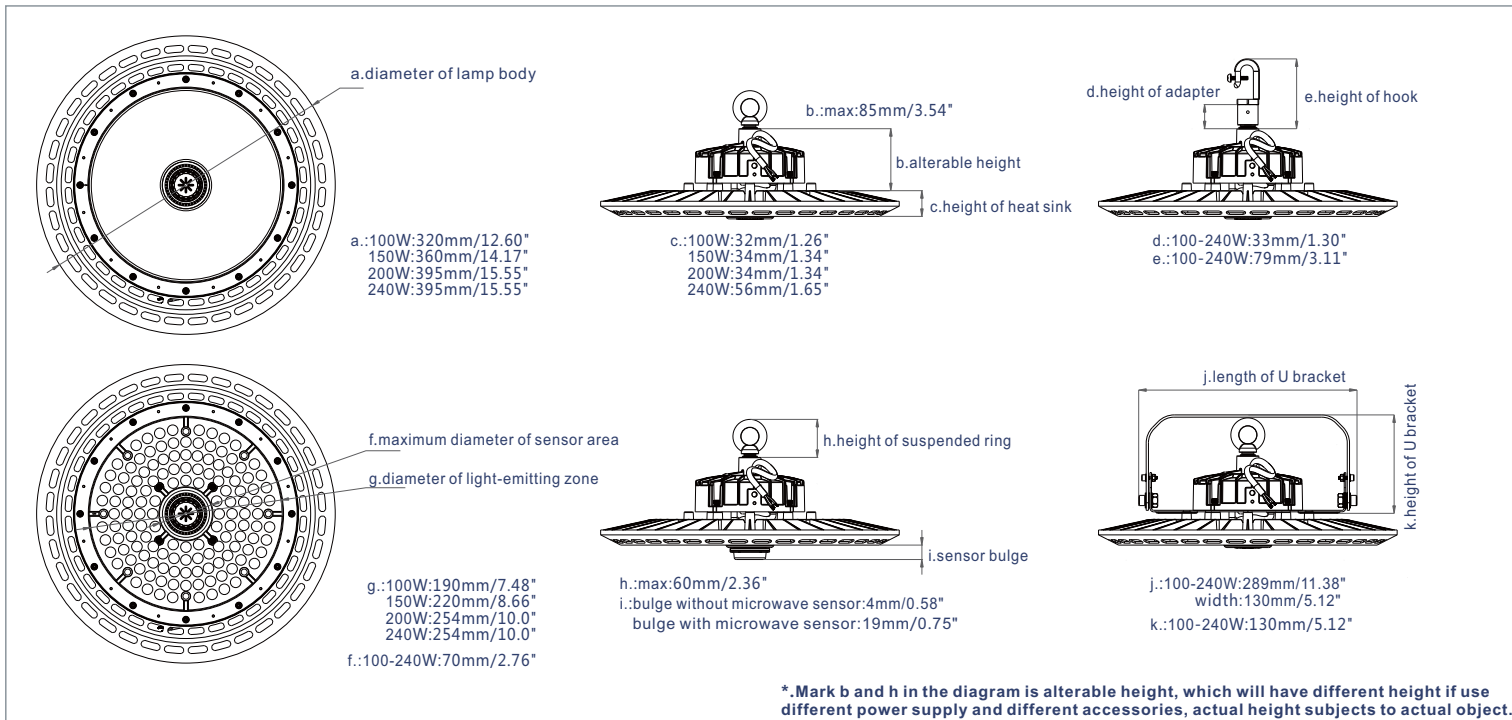

Package information

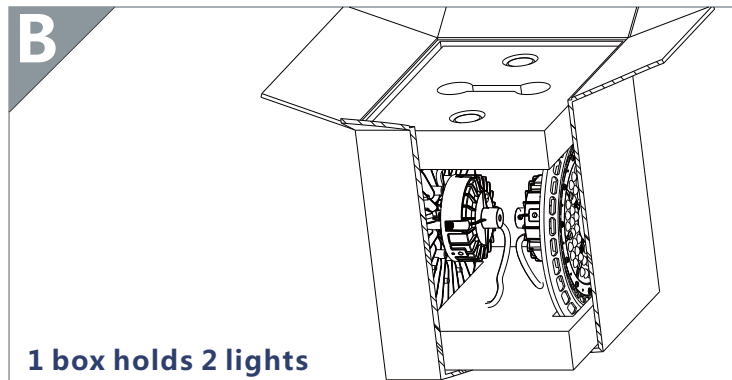
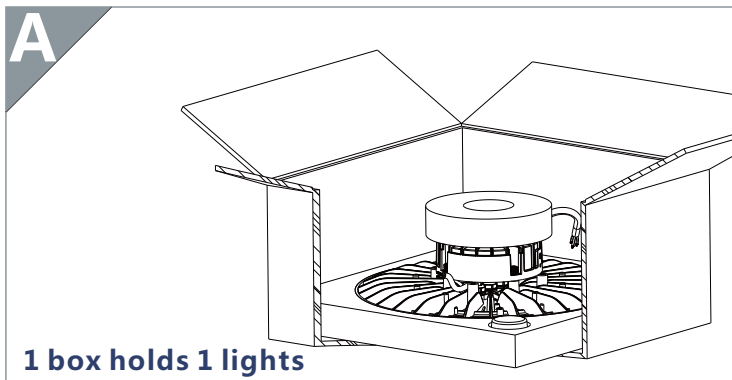

Model	Power	Net weight	box dimension	Pack Quantity	Gross Weight Per CTN
SDYY/SSYY A	100W	①2.80 ②2.80Kg	375*375*175mm	1pcs	①3.65 ②3.65Kg
	150W	①3.85 ②3.85Kg	415*415*185mm	1pcs	①4.85 ②4.85Kg
	200W	①4.20 ②4.90Kg	450*450*185mm	1pcs	①5.35 ②6.00Kg
	240W	①5.95 ②6.40Kg	450*450*205mm	1pcs	①7.20 ②7.60Kg
SDYY/SSYY B	100W	①2.80 ②2.80Kg	375*315*375mm	2pcs	①6.70 ②6.70Kg
	150W	①3.85 ②3.85Kg	415*320*415mm	2pcs	①8.90 ②8.90Kg
	200W	①4.20 ②4.90Kg	450*325*450mm	2pcs	①9.75 ②11.1Kg
	240W	①5.95 ②6.40Kg	450*370*450mm	2pcs	①13.5 ②14.2Kg

* ①:AW/AH, ②:HV

* SDYY: dimming type, SSYY: microwave sensing type.

* Installation accessories of U bracket can be directly assembled into the lamp when leaving the factory and be packed in one package. As net weight of bracket equals to 1kg, if it is assembled to product, the basic weight should additionally add 1kg

Reference diagram of accessories



M20 adapter



hook components



U bracket

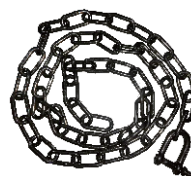

stainless steel chain



safety rope



aluminum lampshade

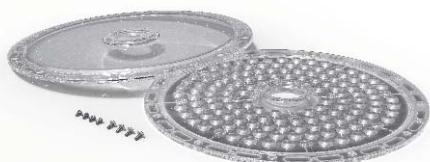

optical lens



sensor



remote controller

Accessories specification

Name	Specification	Model	Part coding	Application scope
adapter	M10	CB2-M10ZM20-001-A	695-01-0028-001	CB-100~240-AW-XXK-SZYY-LF CB-100~150-AW-XXK-SZYY-DR CB-100-AW-XXK-SZYY-SS
	M12	CB2-M12ZM20-001-A		CB-200~240-AW-XXK-SZYY-DR CB-150~240-AW-XXK-SZYY-SS
Hook components	M10	CB2-150-AW-DG-001-A	695-01-0502-349	CB-100~240-AW-XXK-SZYY-LF CB-100~150-AW-XXK-SZYY-DR CB-100-AW-XXK-SZYY-SS
	M12	CB2-240-AW-DG-001-A	695-01-0502-350	CB-200~240-AW-XXK-SZYY-DR CB-150~240-AW-XXK-SZYY-SS
U bracket	General	CB2-240-AW-U-001-A	695-01-0502-352	CB-100~240-AW-XXK-SZYY
Stainless steel chain	0.5 M	CB2-100-AW-P-TL-003-A	695-06-0028-018	CB-100~240-AW-XXK-SZYY
	1.0 M	CB2-100-AW-P-TL-002-A	695-06-0028-007	CB-100~240-AW-XXK-SZYY
	1.5 M	CB2-100-AW-P-TL-001-A	695-06-0028-003	CB-100~240-AW-XXK-SZYY
Safety rope	1.5 M	CB2-100-AW-P-GS-001-A	695-06-0028-009	CB-100~240-AW-XXK-SZYY
Aluminum lampshade	70°	CBS-100-AW-LP-70-001	695-01-0502-589	CB-100-AW-XXK-SZYY
		CBS-150-AW-LP-70-001	695-01-0502-590	CB-150-AW-XXK-SZYY
		CBS-240-AW-LP-70-001	695-01-0502-591	CB-200~240-AW-XXK-SZYY
100W PC lens	90deg	CBS-100-LENS-90-001	695-11-0914-050	CB-100-AW-XXK-SZYY
	60deg	CBS-100-LENS-60-001		
150W PC lens	90deg	CBS-150-LENS-90-001	695-11-0914-051	CB-150-AW-XXK-SZYY
	60deg	CBS-150-LENS-60-001		
200-240W PC lens	90deg	CBS-240-LENS-90-001	695-11-0914-052	CB-200~240-AW-XXK-SZYY
	60deg	CBS-240-LENS-60-001		
Microwave sensor	Pluggable	CBS-SENSOR-001	695-01-0502-592	CB-100~240-AW-XXK-SDYY-LF
Remote controller	Infrared	CBS-MSY-001	695-01-0502-593	CB-100~240-AW-XXK-SSYY

* Please pay attention to the marked colorful words in application range, each accessory shall be used in specified range.

* Blue means the applicable range of power of the accessory, green means the applicable range of function of that series, yellow means the matched power supply brand

* LF=Lifud power supply, DR=Daermy power supply, SS=Sosen power supply.

* Z=lamps with any functions will be applicable to this series; if only applicable to lamp with particular function, alphabet there shall be D, S, E, G or blank.

* YY=that series is applicable to all type, please consult first if you have any questions.

Motion-sensing Function

The sensor can detect brightness of ambient light and moving objects, with insufficient ambient light, the sensor switch on the lamp when motion is detected.

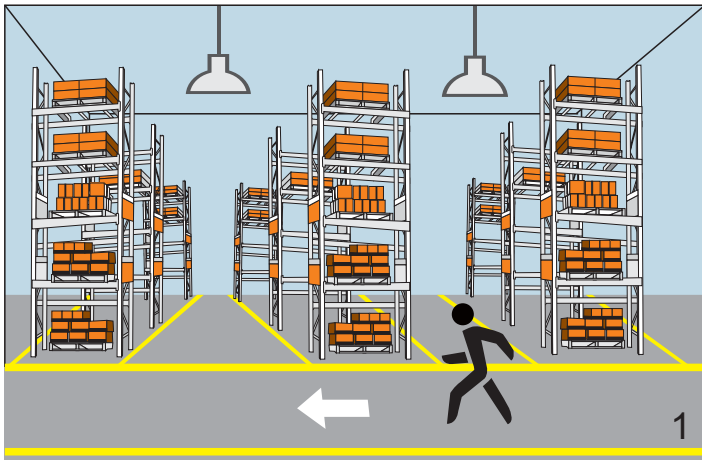

When brightness of ambient light $> 50\text{Lux}$, the sensor won't switch on the lamp even if motion is detected.

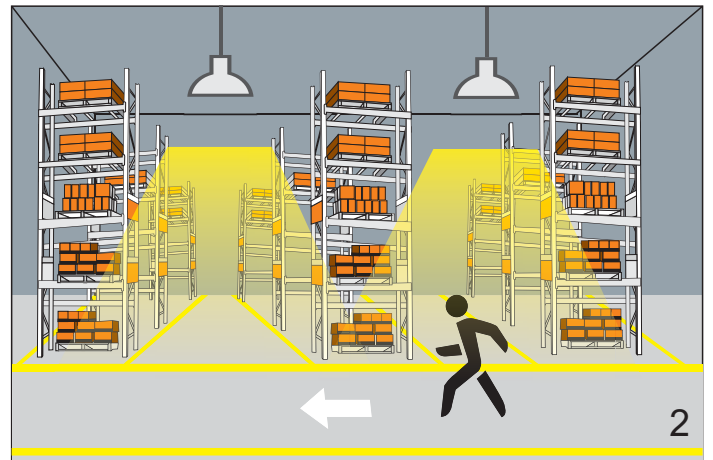

When brightness of ambient light $< 50\text{Lux}$, the sensor will switch on the lamp when motion is detected.

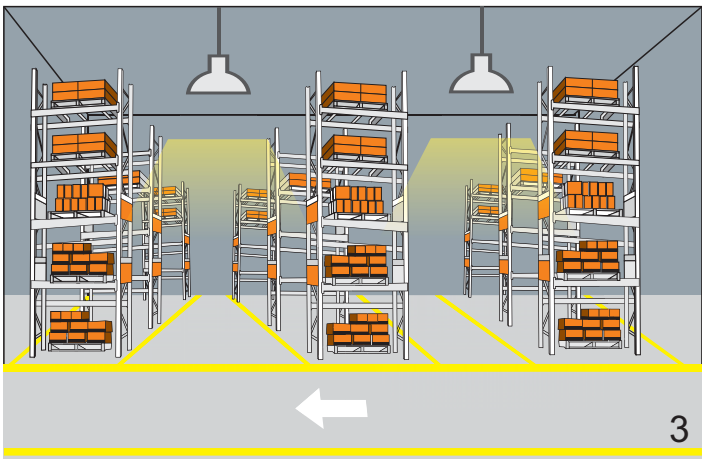

After pedestrian left detection range, brightness of the lamp will decrease to 30% after 5 minutes.

* The above examples are factory default setting parameters, please contact us if need any change or purchase remote controller separately to change parameters as you like.

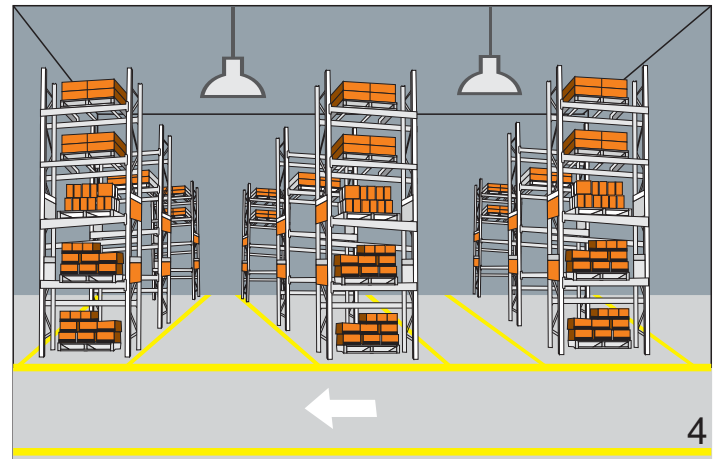

If no pedestrian pass the detection range, the sensor will switch off the lamp after 30 minutes.





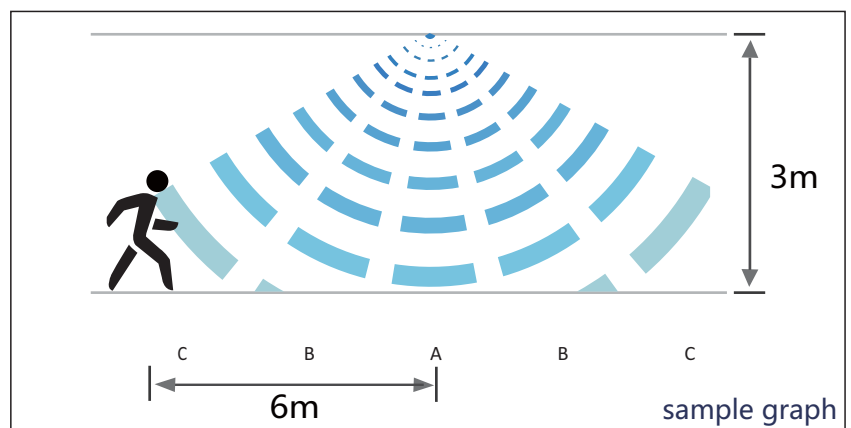





Technical parameter of sensor

working voltage	DC12V
microwave frequency	5.8GHz ISM frequency band
microwave power	$< 0.3\text{mW}$
detection angle	120°
detection range	Max.(D x H): 12m x 15m
detection speed	0.5~3m/s



Remote controller setting

All application parameters of the sensor can be set and alternated through remote controller. Function description of remote controller is as follow.

Button	Function	Description																														
	ON/OFF	Press the "ON/OFF" button, the light goes to constant on or constant off, sensor is disabled. Press "Reset" or "Auto Mode" to quit from this mode.																														
	Reset	Press "Reset" button, sensing function restores to default setting.																														
	Auto Mode	Press "Auto Mode" button, the sensor starts to work and all parameter setting will be remained the same as the previous status before the light is set constant on or constant off.																														
	Test pattern	<p>The button "Test(2s)" is for factory testing purpose only. The sensor will go to test mode.</p> <p>Detection sensitivity: 100%</p> <p>Hold time: 2 s</p> <p>Stand-by period: 0 s</p> <p>Daylight sensor: disable</p> <p>Test mode can be quit by pressing any button</p>																														
		<table border="1"> <thead> <tr> <th>Scene mode</th> <th>Detection area</th> <th>Hold time</th> <th>Daylight sensor</th> <th>Stand-by period</th> <th>Stand-by dimming level</th> </tr> </thead> <tbody> <tr> <td>Sc1</td> <td>100%</td> <td>30S</td> <td>2Lux</td> <td>1min</td> <td>10%</td> </tr> <tr> <td>Sc2</td> <td>100%</td> <td>5min</td> <td>10Lux</td> <td>10min</td> <td>10%</td> </tr> <tr> <td>Sc3</td> <td>100%</td> <td>10min</td> <td>50Lux</td> <td>30min</td> <td>10%</td> </tr> <tr> <td>Sc4</td> <td>100%</td> <td>30min</td> <td>Disable</td> <td>+ ∞</td> <td>10%</td> </tr> </tbody> </table>	Scene mode	Detection area	Hold time	Daylight sensor	Stand-by period	Stand-by dimming level	Sc1	100%	30S	2Lux	1min	10%	Sc2	100%	5min	10Lux	10min	10%	Sc3	100%	10min	50Lux	30min	10%	Sc4	100%	30min	Disable	+ ∞	10%
Scene mode	Detection area	Hold time	Daylight sensor	Stand-by period	Stand-by dimming level																											
Sc1	100%	30S	2Lux	1min	10%																											
Sc2	100%	5min	10Lux	10min	10%																											
Sc3	100%	10min	50Lux	30min	10%																											
Sc4	100%	30min	Disable	+ ∞	10%																											
	Detection area (sensitivity)	Set the sensor's sensitivity and detection area of detecting moving objects.																														
	Hold time	Refers to the time period the lamp remains at 100% illumination after no motion detected.																														
	Stand-by dimming level	After hold time, the lamp will have faint light instead of switching off immediately. Here the setting is 100% of faint light, which is the stand-by dimming level																														
	Stand-by period	The time the lamp keeps on stand-by dimming level																														
	Brightness	Set threshold value, when ambient light is lower than threshold value, sensor will respond.																														

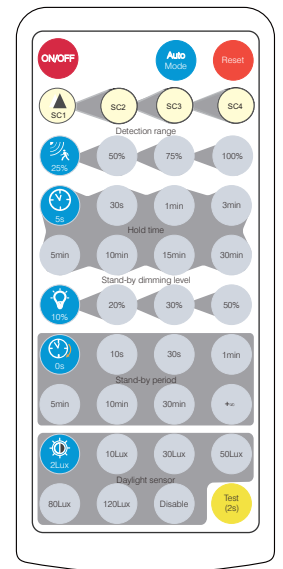

As the control angle of the Infrared Remote Controller is fixed (15°), if sensors are installed too close to each other, settings of both sensors will be configured. Please refer to the below chart for the distance of the installation of the sensor: There may have slight deviations between dimension in the diagram and the real one! The following is only for reference.

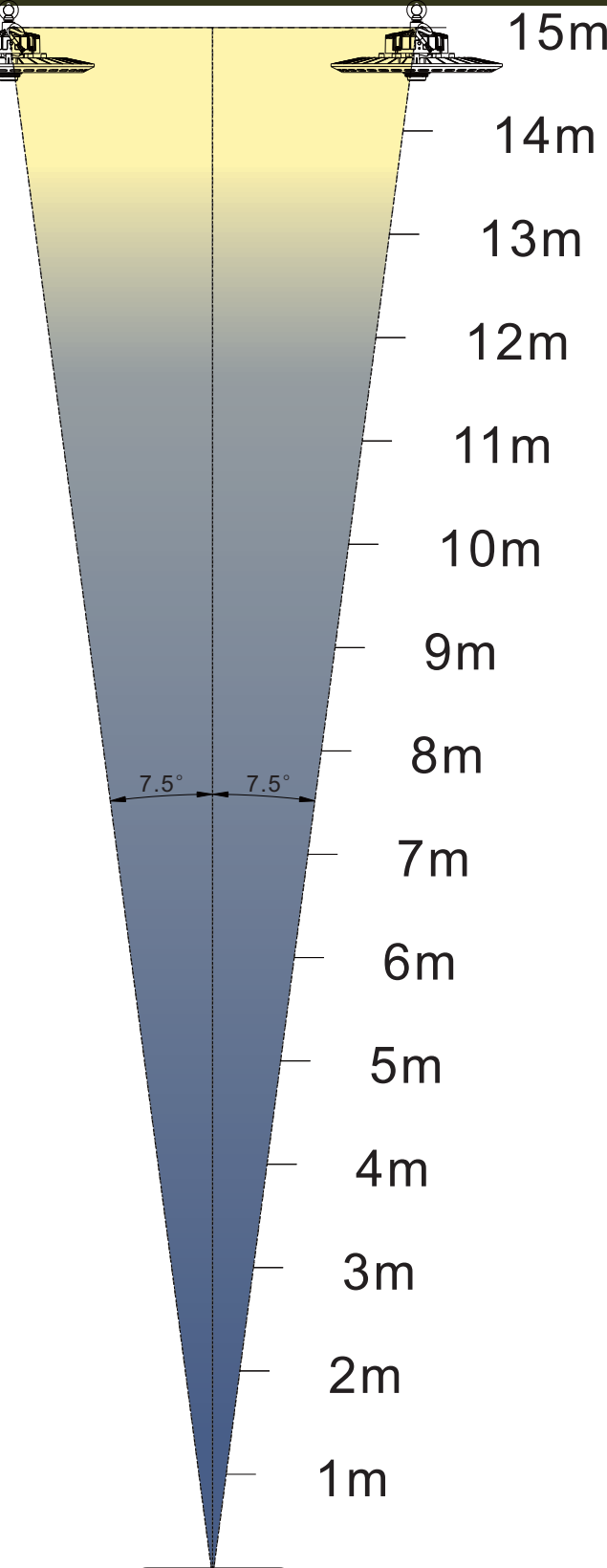

Mounting height	Distance between sensors
15m	3.95m
14m	3.67m
13m	3.42m
12m	3.16m
11m	2.89m
10m	2.63m
9m	2.37m
8m	2.11m
7m	1.84m
6m	1.58m
5m	1.32m
4m	1.05m
3m	0.79m
2m	0.53m
1m	0.26m

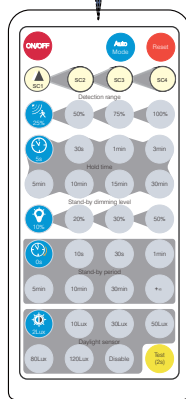

Product Installation

Suspended ring installation

1. Please prepare 1 ceiling hook and matched installation screws and install them into installation carrier reaching bearing requirement;
2. Screw suspended ring of the lamp into screw connection on the top of the lamp body and be careful not to omit the auxiliary skidproof gasket. If there is auxiliary skidproof screw near the screw connection, please tighten it up after installing the suspended ring.
3. Prepare one iron chain as extension carrier, then hook the lamp body on reserved ceiling hook.

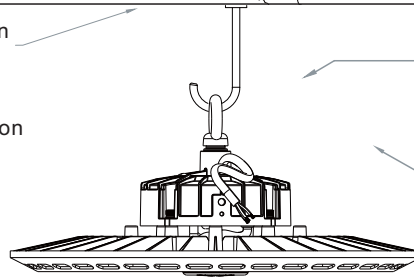

- AC INPUT
- L (brown/black wire)
 - L1 (yellow/red wire, Emergency)
 - N (blue/white wire)
 - GND (yellow&green/green wire)
- 1-10V dimming
- Dim- (white /gray wire)
 - Dim+ (blue/purple wire)

hook installation

1. Please prepare 1 ceiling hook and matched installation screws and install them into installation carrier reaching bearing requirement.
2. Screw hook of the lamp into screw connection on the top of the lamp body and be careful not to omit the auxiliary skidproof gasket. If there is auxiliary skidproof screw near the screw connection, please tighten up it and the skidproof gasket on adapter after installing the suspended ring.
3. Unscrew the anti-off screws in the opening of hook, and hook the lamp body on the ceiling hook.
4. Prepare one iron chain as extension carrier, then tighten anti-off screws up in the opening of hook.

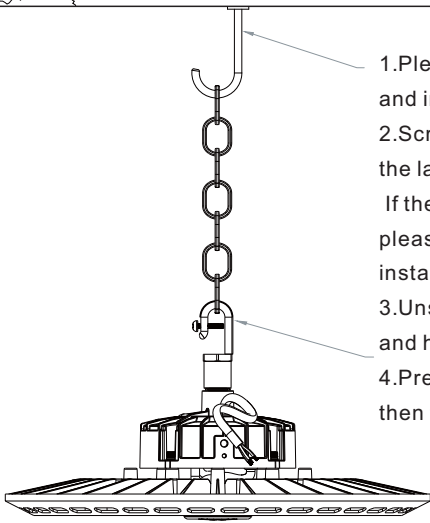

Half inch pipe installation

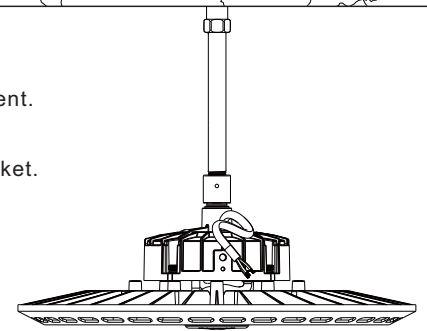

Pipe installation is only suitable for specific installation environment, as we only provide M20 adapter, thus matched pipe end shall conform to below requirements.

1. Ensure pipe can reach weight bearing requirements;
2. Pipe must has M20 screw connection;
3. Thread depth of pipe <25mm, recommend 20mm.

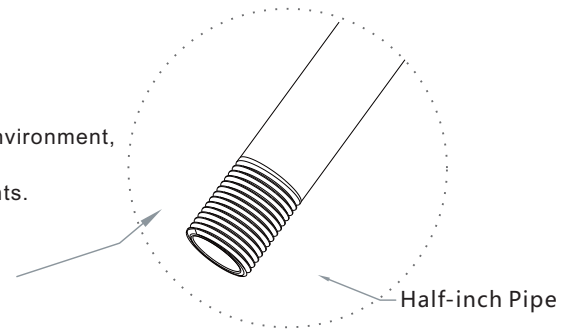

Half-inch Pipe

Pipe installation can also match with center-outlet power supply to realize concealed installation which threads wire from the pipe. If this requirement is needed, please consult first.

U Bracket Ceiling or Wall Installation

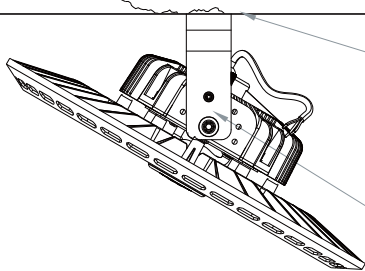

1. Prepare 2φ10mm expansion screw and ensure their material and installation position conform to bearing requirement, then drill two holes with ≤10mm in advance;
2. Insert expansion screws into holes and make holes in the bracket corresponding to head of expansion screws, then tighten expansion screws up;
3. Dismantle small auxiliary screws on both sides, slightly loose fixing screws of bracket and rotate lamp body to suitable installation angle;
4. Install small auxiliary screws of the bracket back, finally tighten up all main screws and auxiliary screws.

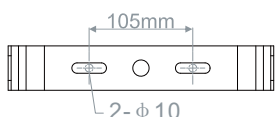
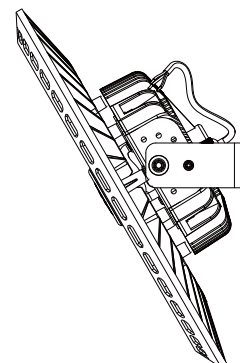

Recommended dimension of drilling hole

Installation requirements

1. Disconnect power supply, and read product instructions carefully;
2. Ensure installation accessories and installation environment conform to bearing requirement;
3. Check whether the installation accessories are damaged or not, and install accessories to lamp reliably;
4. Different installation environment match corresponding installation accessories, do not use or change at will;
5. If the installation fittings has auxiliary parts such as skidproof screw, notice how it works, please do not ignore it;
6. If the light is installed in vibration environment, please add anti-falling safety rope to ensure reliability of installation;
7. Connect power supply wire reliably according to specified polarity; I-type lamp with grounding line shall be earthed reliably and the connection points must have insulation measures;
8. When the installation is completed, check whether all parts is reliable and can work properly.

Notice

1. Please first read the product specification carefully, make sure the using environment conform to specification, then it can be used;
2. Please confirm the input voltage and frequency before use;
3. This product must be installed by professionals;
4. If there is any damage to the power wire or shell of the product, it shall be taken as defective product and do not use it;
5. Dangerous high voltage, non-professionals are not allowed to maintain the product;
6. If external soft cable or soft wire of the light is damaged, it shall be replaced by manufacturer or service agent or personnel with similar qualification to avoid danger;
7. Corrosivity in the using environment can't exceed the specified anti-corrosion grade, if you have special requirement, please first consult with our company.