

SC-2216TM-XXD-XX-12&24V



Available colors



Features

- 2216 Full Spectrum LEDs
- CRI95
- CE, ROHS, 3 years warranty
- The LED strip can be cut to meet requirements of different length.
- By complementing the missing parts of spectrum, the high-CRI full spectrum LED light source the product used, which is eco-friendly, improves spectrum continuity and saturation of color gamut of the light source. Therefore, color value of the RI~R15 standard sample is greatly improved and blue light hazard and rich bluing of traditional LED light source is effectively reduced, making the product more applicable to lighting front.
- Customized packaging.

Application

- Stage lighting
- Festival, activities, exhibition lighting, etc
- Backlight of signage
- Contour lighting
- Landscape decoration lighting
- Indoor beautification

Technical parameters

Model	Color	Lumen	LED Qty. (leds/m)	Rated Watt (w/m)	LED Type	Beam angle (degree)	DC Voltage (V)	IP	CRI
SC-2216TM-12D-XX	W	700	120	9.6	2216	120	12/24	20	95
	NW	650							
	WW	580							
SC-2216TM-24D-XX	W	1380	240	19.2					
	NW	1250							
	WW	1120							
SC-2216TM-28D-XX	W	1650	280	24					
	NW	1560							
	WW	1380							
SC-2216TM-30D-XX	W	1750	300						
	NW	1660							
	WW	1450							

Dimensions (unit: mm/inch)

SC-2216TM-12D-XX-12V

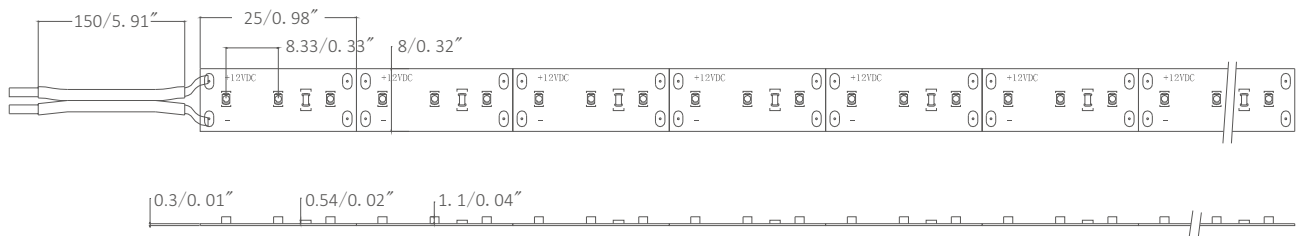

SC-2216TM-12D-XX-24V

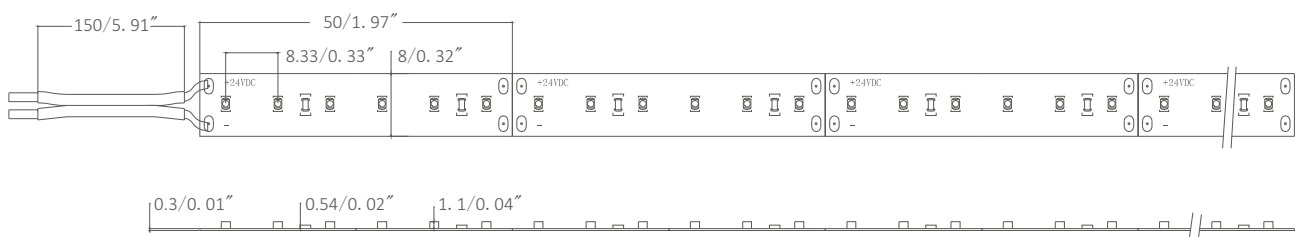

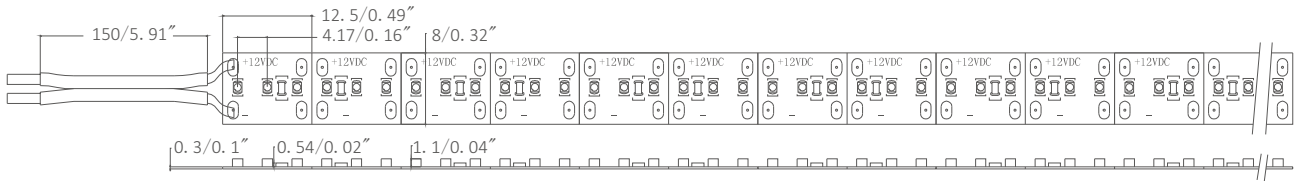
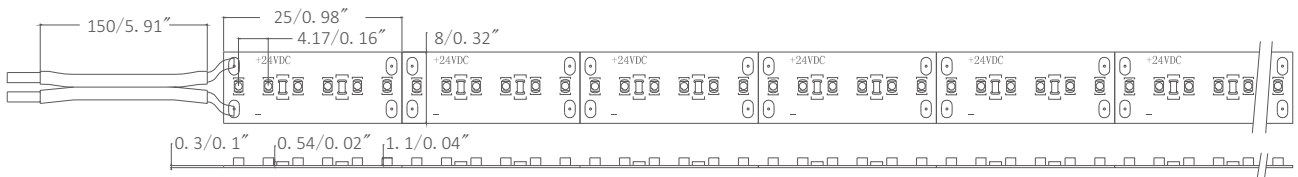
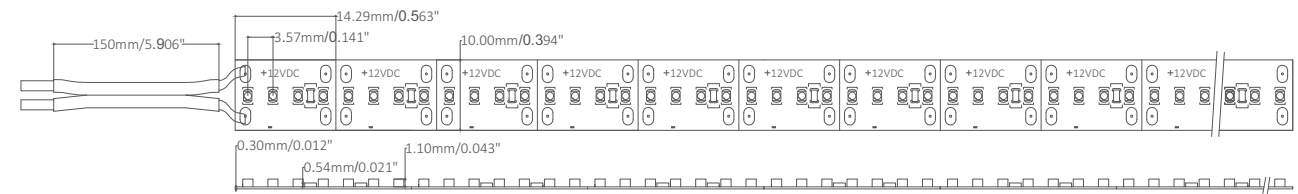
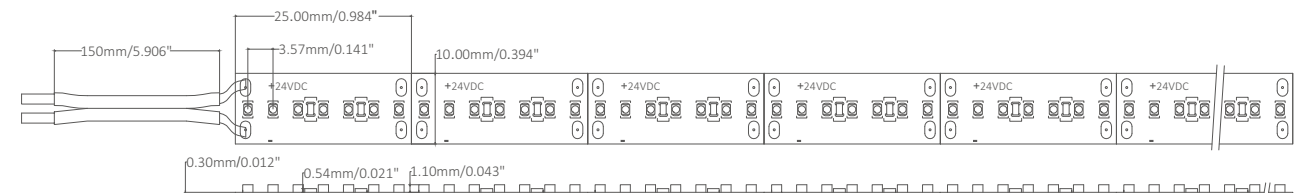
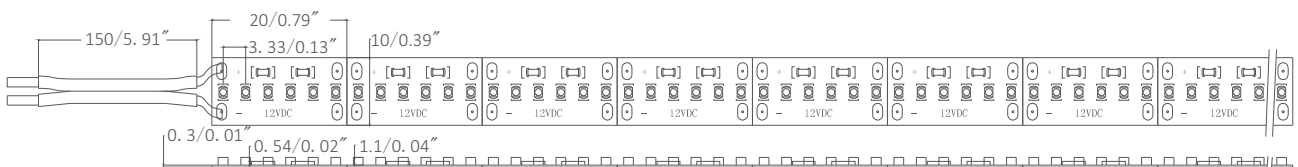
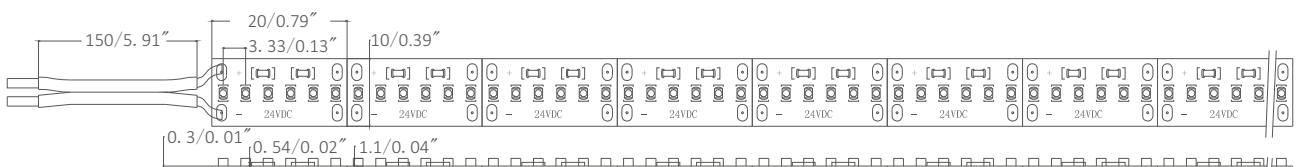
SC-2216TM-24D-XX-12V

SC-2216TM-24D-XX-24V

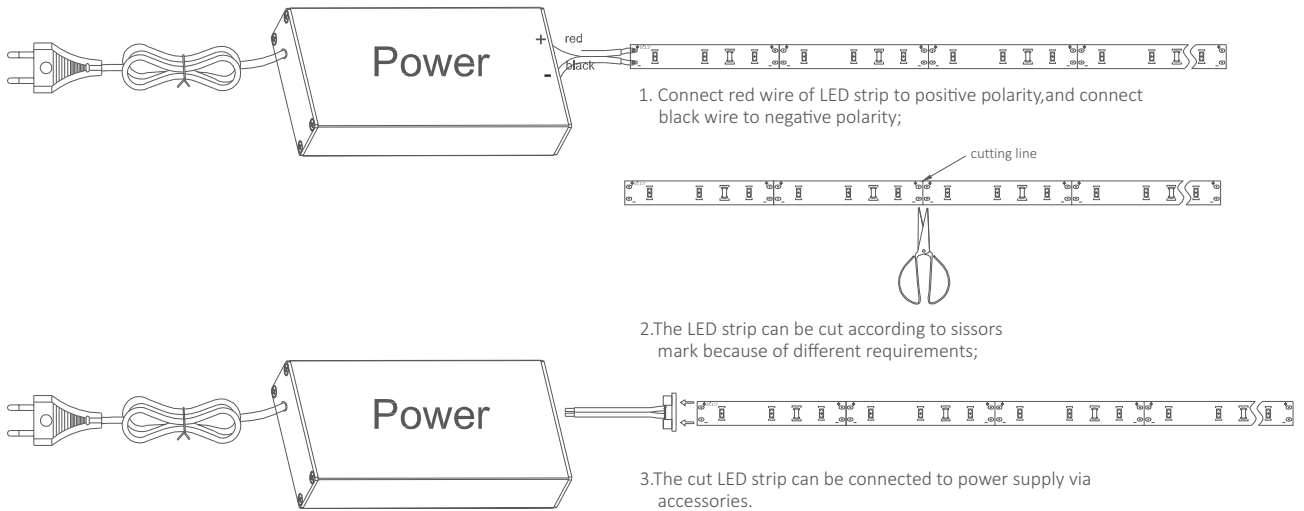
SC-2216TM-28D-XX-12V

SC-2216TM-28D-XX-24V

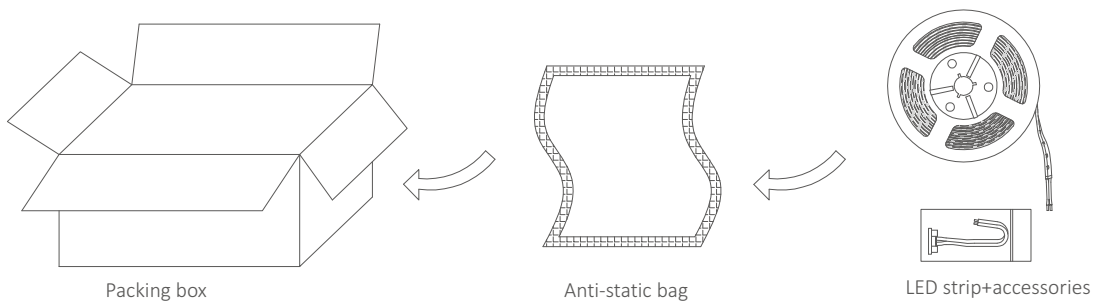
SC-2216TM-30D-XX-12V

SC-2216TM-30D-XX-24V

Wiring diagram



Packaging information



Installation requirement

- The LED strip and accessories can't be squeezed or folded;
- PCB conductive parts can't be damaged when installation;
- Installation must conform to electrical safety standard. The LED strip can only be installed by professionals;
- Ensure power supply transform operating load with transformer;
- When install on metal or conductor surface, insulation protection need to be provided to the contact area;
- Observe positive and negative polarity, ensure correct connection to avoid damaging LED strip;
- When installation, please prevent static electricity;
- The product need anti-corrosion environment, such as, avoiding damp, water drop or other adverse elements.



Yijia Industrial Park, Fuqian Road, Guanlan Town, Baoan, Shenzhen, Guangdong, China

Tel: +86-755-27608650
 Fax: +86-755-27608651
www.signcomplex.com
sales@signcomplex.com